

EXACTECH|HIP

Operative Technique



Logical™ Acetabular Cup and Liner



TABLE OF CONTENTS

INTRODUCTION	1
OPERATIVE TECHNIQUE	
Preoperative Planning	2
Acetabular Preparation	4
Acetabular Trialling and Positioning	6
Implant Acetabular Cup Insertion	8
Determine Screw Location and Drill Depth	10
Determine Screw Length	12
Insert Screws	12
Trial Liner Evaluation	14
Liner Placement	14
Positioning	16
Liner Removal	17
SIZING GUIDE	18
INSTRUMENTS LISTING	19
PREOPERATIVE TEMPLATES	23
IMPLANTS LISTING	24

INDICATIONS

Components of the Hip Replacement System are intended to replace a hip joint where bone stock is sufficient to support the implant. When a surgeon has selected prosthetic replacement as the preferred treatment, the devices are indicated for:

- Non-inflammatory degenerative joint disease including osteoarthritis or avascular necrosis
- Inflammatory joint disease including rheumatoid arthritis
- Correction of functional deformity including congenital hip dysplasia
- Traumatic injury involving the hip joint including traumatic arthritis or femoral head or neck fracture
- Failed previous hip surgery including internal fixation or joint fusion, reconstruction, hemiarthroplasty, surface replacement, or total replacement

Spartan Hip femoral stems and Logical Acetabular Cups are intended for cementless fixation only.

Logical constrained liner components are indicated particularly for patients at high risk of hip dislocation due to a history of prior dislocation, bone loss, joint or soft tissue laxity, neuromuscular disease or intraoperative instability.

CONTRAINDICATIONS

In general, prosthetic components require adequate bone support for correct fit and function. The use of prosthetic components is therefore contraindicated where any pathological condition may reduce the quantity and or strength of the bone which is supporting the prosthesis. Some contraindications are relative to the extent and severity of conditions and the benefits of prosthetic arthroplasty should be considered based on the patient's overall evaluation and the possibility of alternative treatment. Examples of such conditions include; osteoporosis, osteomalacia, osteogenesis imperfecta, or hypophosphatemia. Other contraindications include:

- Conditions limiting blood supply to the bone or joint.
- Systemic or local infection.
- Previous high dose radiotherapy.
- Psychological or neurological conditions which would restrict the patient's ability or compliance in restricting physical activity.
- Skeletal immaturity
- Conditions or activity which may place excessive load on the components such as; obesity, muscle, tendon & ligament deficiencies, multiple joint disabilities, and Charcot joints.

The Logical constrained liners are contraindicated particularly for active patients.

DETAILED OPERATIVE TECHNIQUE

LOGICAL ACETABULAR CUP AND LINER

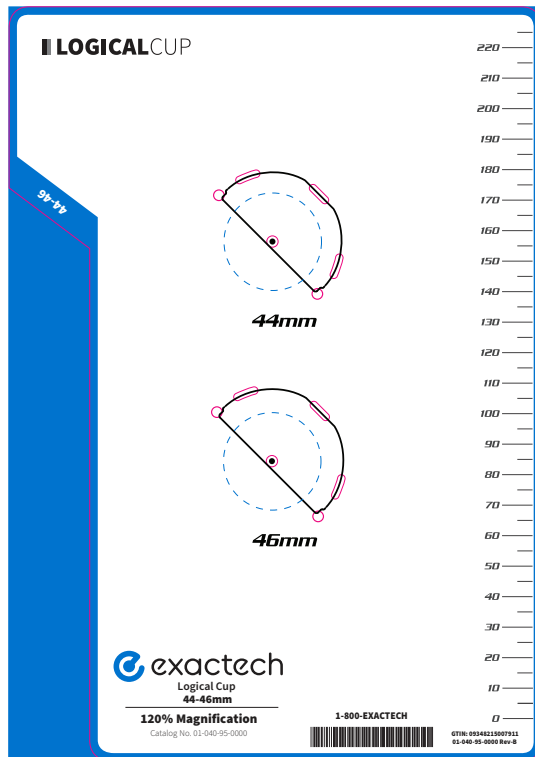

Figure 1

PRE-OPERATIVE PLANNING

Templating

Accurate pre-operative planning and acetabular templating are recommended for obtaining a successful outcome. Estimate the acetabular size utilizing the Logical Cup hip templates along with the appropriate femoral templates in the A/P view. The desired magnification for all imaging should be 120%, which corresponds to the templates provided for the Logical Cup (Figure 1).

For the A/P view, the patient is placed supine with both extremities placed in 15 degrees of internal rotation to position the head and neck parallel to the coronal plane. The radiograph should be centered on the symphysis pubis and should clearly show the acetabular construct with the endosteal and periosteal contours of the femoral head, neck and proximal femur.

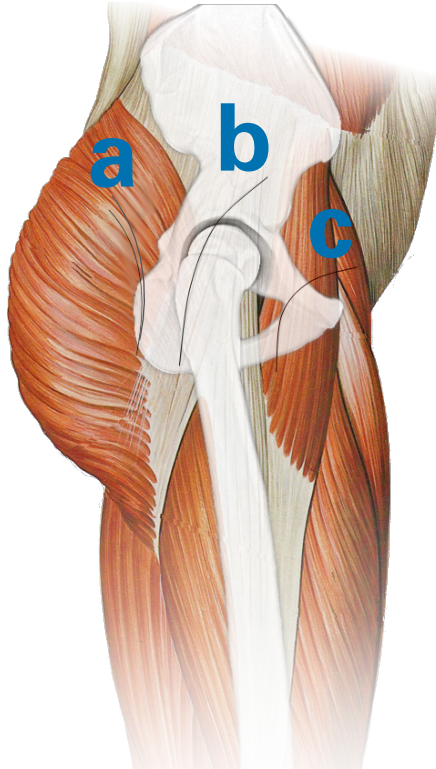

Figure 2

For traditional ‘hard-copy’ templating, estimate the acetabular component size by placing the overlay templates on the film selecting a size that matches the contour of the patient’s acetabulum without the removal of excessive subchondral bone. To ensure a congruent fit, the medial position of the acetabular template should be lateral to the lateral aspect of the teardrop with the inferior part of the cup level with the obturator foramen and the superior position marked by the true superior edge of the acetabulum. Templating should be done on the affected side, but the contralateral side may also be templated to confirm size.

Mark the center of rotation and the expected acetabular component size on the radiograph of the femur.

Note: For digital templating, follow the software manufacturer’s instructions for use while following the preceding instructions regarding placement and implant fit

This operative technique assumes that the patient has been positioned in the lateral decubitus position. However, the Logical acetabular instrumentation is compatible with any standard approach necessary to gain exposure to the acetabulum (Figure 2).

- a. Posterior approach
- b. Posterolateral/anterolateral approach
- c. Anterior approach

DETAILED OPERATIVE TECHNIQUE

LOGICAL ACETABULAR CUP AND LINER

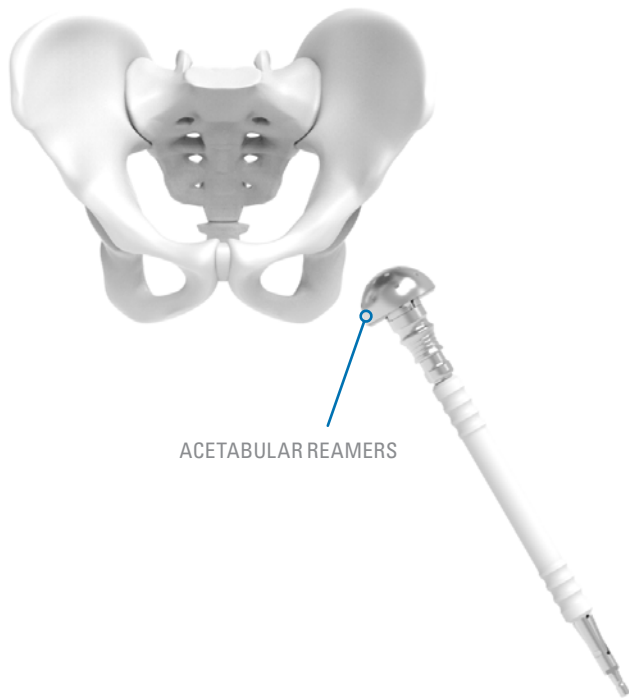

Figure 3a



Figure 3b

ACETABULAR PREPARATION

Osteophytes should be removed to gain assessment of the true acetabular rim. Reaming should be sequential and start with the smallest reamer that conforms to the acetabular cavity (*Figure 3a*). Reaming to the circumferential line on the reamer will mimic a full hemisphere. Gradually enlarge the acetabulum by reaming articular cartilage until a continuous surface of cancellous bone is exposed (*Figure 3b*).

Note: A 54mm reamer will ream a hemispherical cavity 54mm in diameter, and a 54mm trial cup is $\varnothing 54\text{mm}$. A 54mm Logical cup is 54mm + 1mm of porous coating. This coating thickness of 1mm will give a press fit (*Figure 4*).

To provide 1mm of press-fit when implanting the Logical Cup, reaming should stop on an even size reamer and the labeled implant size should match the final reamer.

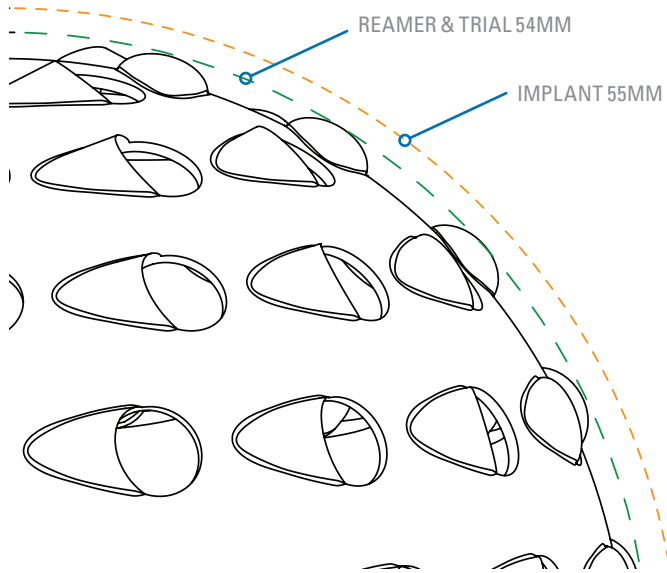

Figure 4

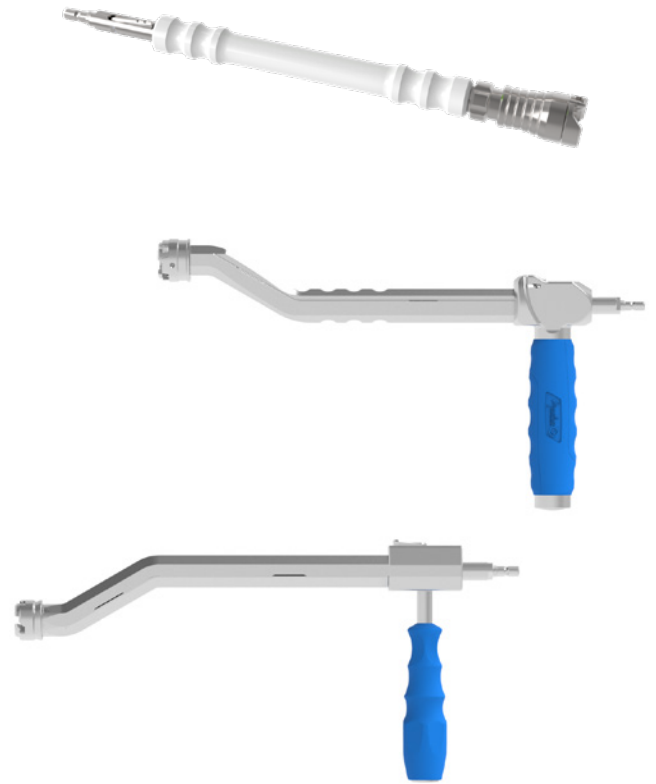

Figure 5

Reamer handles are available in straight and offset (Figure 5).

DETAILED OPERATIVE TECHNIQUE

LOGICAL ACETABULAR CUP AND LINER

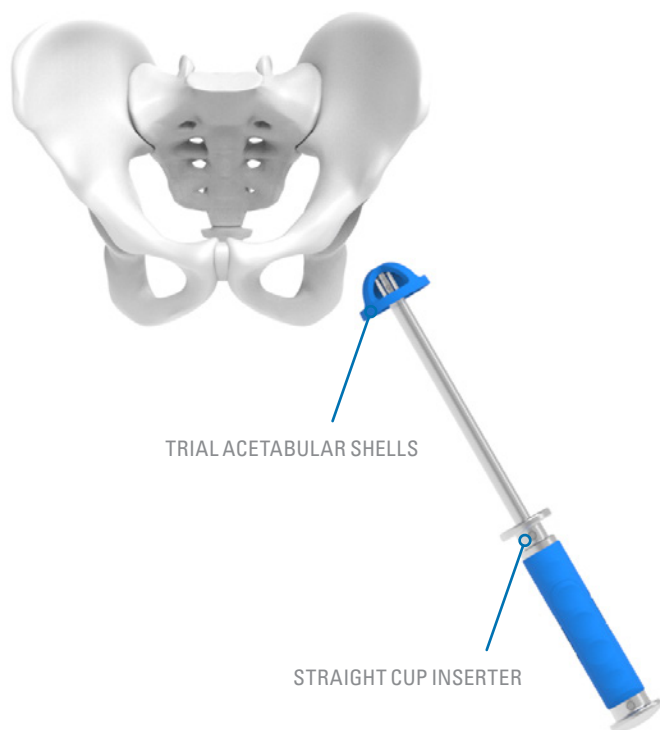

Figure 6

Part Number	Diameter
112-152-191	44mm
112-152-192	46mm
112-152-193	48mm
112-152-573	50mm
112-152-195	52mm
112-152-196	54mm
112-152-197	56mm
112-152-198	58mm
112-152-199	60mm
112-152-200	62mm
112-152-201	64mm
112-152-202	66mm
112-152-203	68mm

Table 1
Trial Acetabular Cups

ACETABULAR TRIALING AND POSITIONING

Trial cups are available to evaluate the size and position of the final implant.

Thread the trial cup onto the end of the cup inserter and position the trial cup in the desired orientation by maneuvering the cup impactor (*Figure 6*).

Instrument Identification:

Trial acetabular cups are identified by the size marked on the top rim. They are also color-coded to match with compatible trial liners. Each trial cup size corresponds to a Logical cup implant size (*Table 1*). Refer to the Logical Implants Sizing Chart in this technique for more details.

DETAILED OPERATIVE TECHNIQUE

LOGICAL ACETABULAR CUP AND LINER

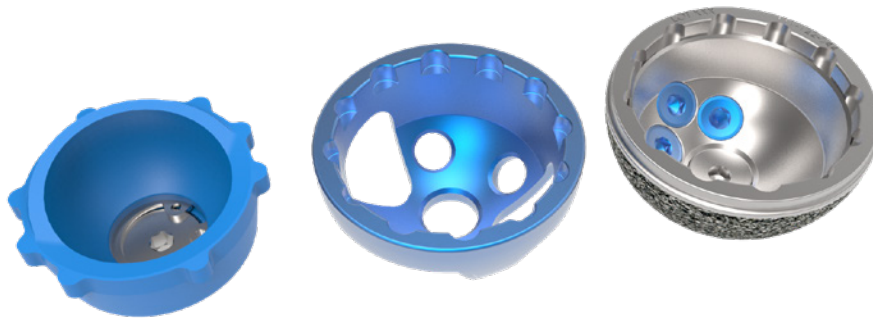

Figure 7

Example above:

Connection type B shown, the blue trial liner matches the blue trial shell, which matches the blue coloring on the box label and the hole covers in the implant (Figure 7).

DETAILED OPERATIVE TECHNIQUE

LOGICAL ACETABULAR CUP AND LINER

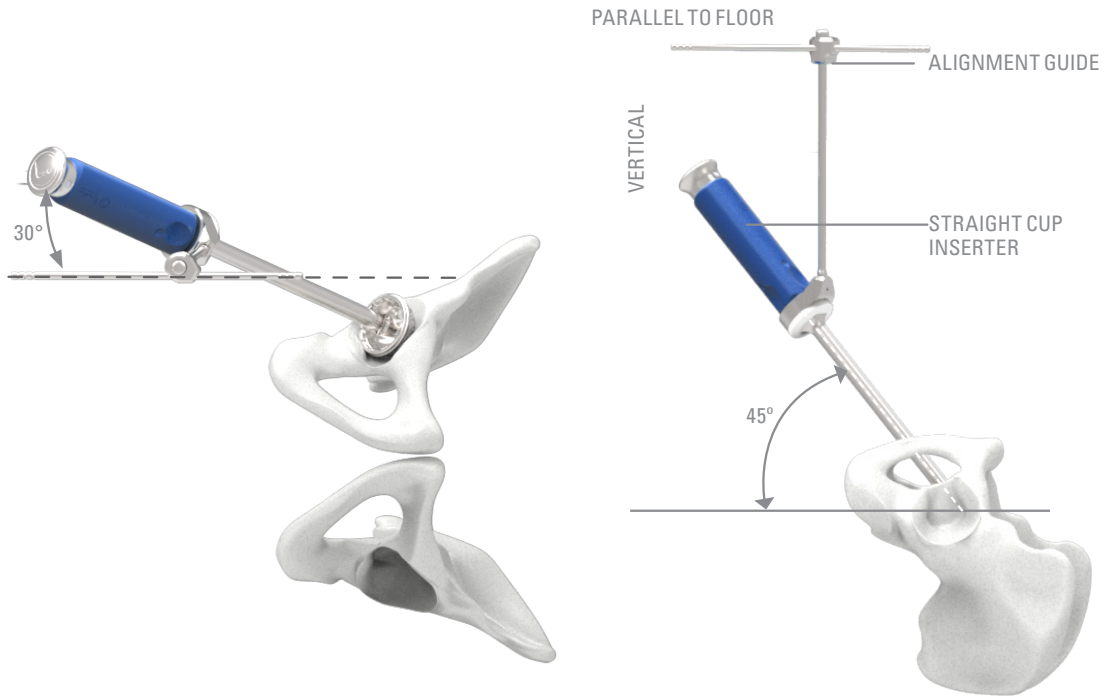

Figure 8

ACETABULAR CUP IMPLANTATION

Thread the appropriate size prosthetic cup onto the impactor. The alignment guide can be attached to the impactor to help with anteversion and abduction angles. Seat the cup with a series of firm mallet blows to the end of the impactor. Screw placement can begin once the cup component is securely positioned and the impactor is removed.

Note: The alignment guide indicates 30° of operative anteversion, which equates to 20° of radiographic anteversion (Figure 8). Operative anteversion differs from radiographic anteversion due to the projection of angles on a radiograph.

Optional:

Curved cup inserter options are also available (Figure 9), please inquire for additional instructions for use.

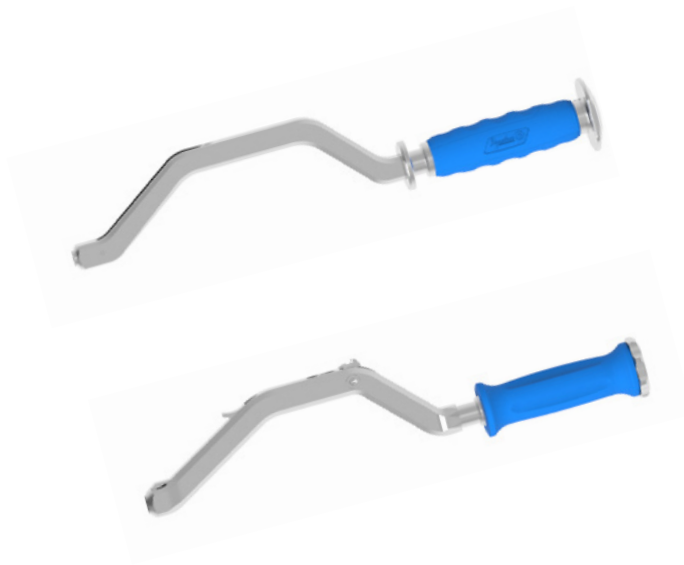

Figure 9

DETAILED OPERATIVE TECHNIQUE

LOGICAL ACETABULAR CUP AND LINER

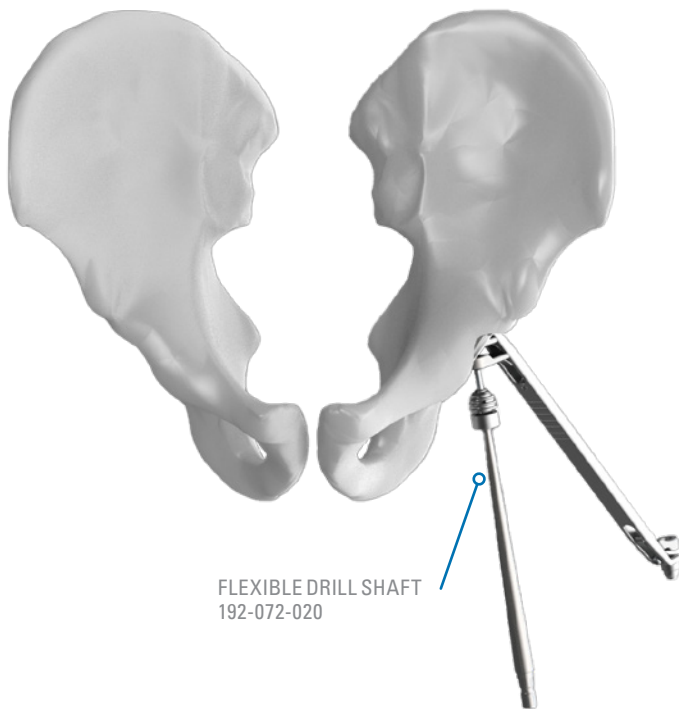

Figure 10a

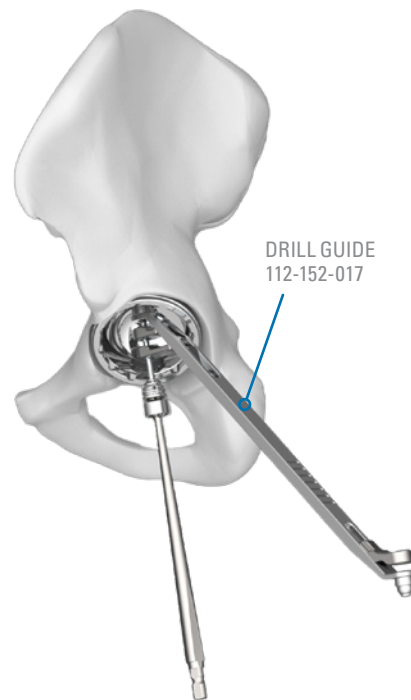

Figure 10b

DETERMINE SCREW LOCATION AND DRILL DEPTH

Determine screw location and select a suitable drill depth (*Figure 10a*). The flexible drill allows a wide range of drilling angles while still being able to apply pressure to the drill (*Figure 10b*).



Figure 11

Instrument operation:

The drill guide has flip-down depth stops at each end. One end has 10mm steps, which allows a 50mm drill to drill a hole at 40, 30 and 20mm deep. While the other end has steps of 5mm, which allows holes to be drilled at 25 and 35mm (Figure 11).

DETAILED OPERATIVE TECHNIQUE

LOGICAL ACETABULAR CUP AND LINER

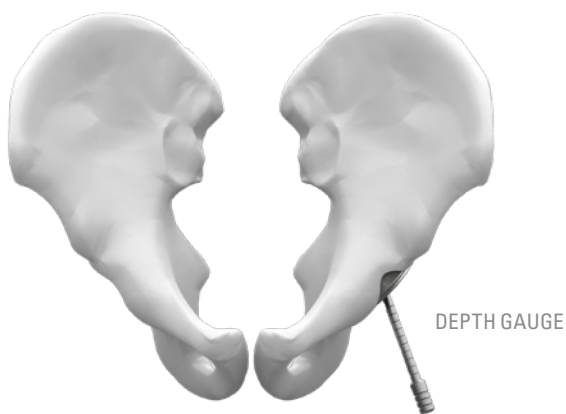

Figure 12

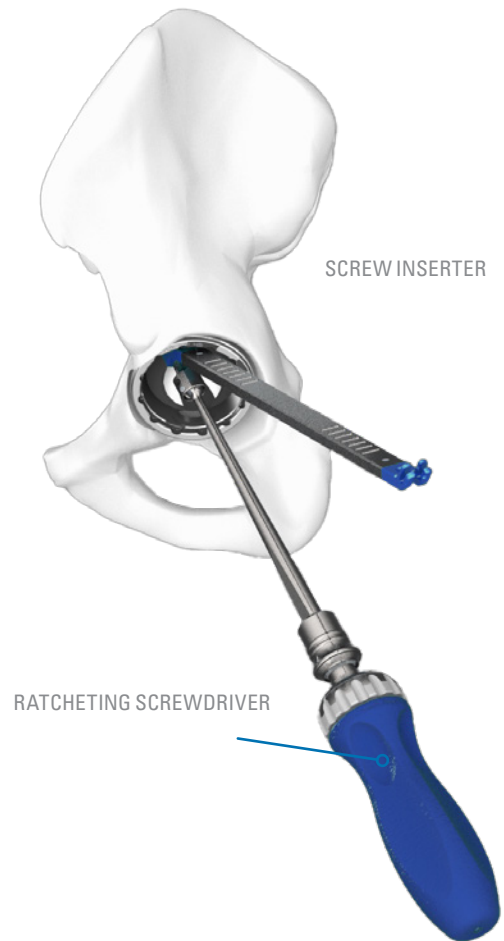

Figure 13

DETERMINE SCREW LENGTH

Use the screw depth gauge to determine the appropriate length screw (*Figure 12*). Due to intrapelvic vascularity, screw placement in the medial aspect of the acetabulum must be carefully considered.

INSERT SCREWS

Screws snap into the screw inserter, allowing them to rotate freely without falling out at any angle (*Figure 13*).

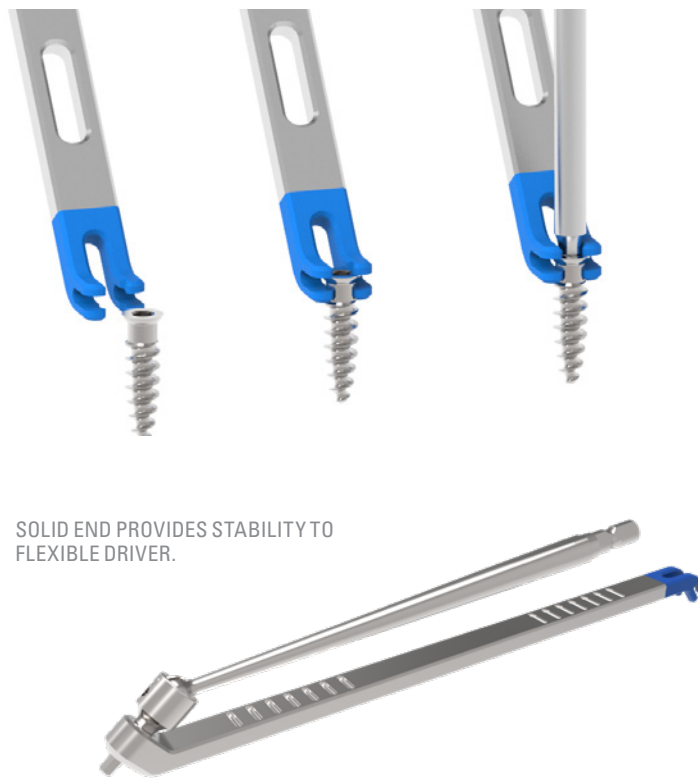

Figure 14

Pull inserter off screw to allow for countersinking of the screw head. Full seating can be confirmed with the use of a trial liner prior to impacting the prosthetic liner, or by manually examining the inner surface. To ensure proper prosthetic liner seating in the cup, screw heads must be seated below the inner surface of the cup. Hex driver available in both tapered and parallel versions (*Figure 14*).

DETAILED OPERATIVE TECHNIQUE

LOGICAL ACETABULAR CUP AND LINER



Figure 15

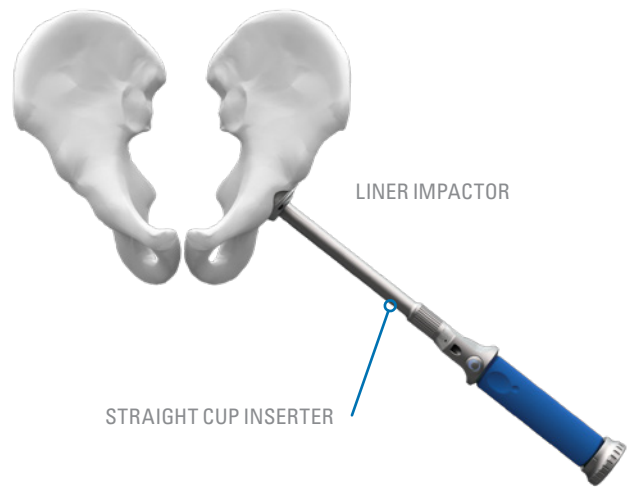

Figure 16

TRIAL LINER EVALUATION

Trial liners that match the prosthetic implant are available to evaluate the optimum position of the final implant. Position the trial liner in the desired orientation and secure it in place with the captured screw using one of the 3.5mm hex screwdriver shafts (*Figure 15*). Apical Screw insertion should not take place until a reduction with the trial liner is completed.

Refer to “Logical Instruments” for information about sizes.

LINER PLACEMENT

Prior to inserting the prosthetic liner, thoroughly irrigate and clean the cup. Insert the prosthetic liner by hand, making sure the face of the liner is parallel with the face of the acetabular cup. The anti-rotation tabs should be lined up with the slots in the cup. Use the liner impactor on the cup impactor to apply a series of firm mallet blows to fully seat the liner (*Figure 16*).



Figure 17

A final inspection of the liner should be done to ensure the liner is firmly locked in place (*Figure 17*).

Neutral liners should be flush with the cup face along the entire rim. Only the lower half of the rim of lipped liners should be flush with the cup face.

DETAILED OPERATIVE TECHNIQUE

LOGICAL ACETABULAR CUP AND LINER

CORRECT

INCLINATION 40-45°
ANTEVERSION 15-20°

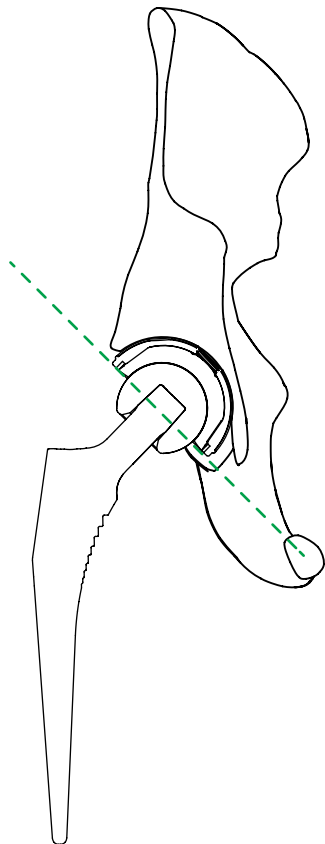

INCORRECT

INCLINATION >45°
ANTEVERSION >20°

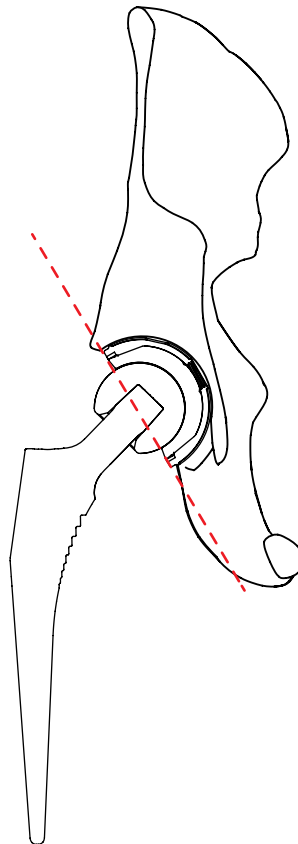

Figure 18

POSITIONING

Current studies have highlighted that correct acetabular component positioning is a key element to success with all types of bearings used in hip replacement surgery. As well as subluxation, impingement, fixation and range of motion, optimum femoral head coverage and mechanical loading of the bearing must also be considered when positioning the acetabular component. Incorrect acetabular component positioning can lead to edge loading and undesirable effects across all bearings, such as dislocation, increased wear, and polyethylene fractures. If a hooded liner is to be inserted, the correct orientation will provide the most coverage of the femoral head component when the hip is fully internally rotated and adducted.

As a general rule, the hood is best positioned superior-posteriorly. However, the final orientation of the hooded liner will be the position that provides the best hip stability, based on surgeon's evaluation, during the trial reduction and ROM assessment of the trial liner.

It must be noted that the orientation and placement of the implant may be adjusted on a case-by-case basis at the surgeon's discretion (*Figure 18*).



Figure 19

POLYETHYLENE LINER REMOVAL

Upon removal of any Liner, inspect the taper and polyethylene locking mechanisms for damage.



Special care should be taken not to lever against the Shell during Liner removal.

- a. Locate a 3.5mm drill bit included in the Kit.
- b. Drill a pilot hole into the dome of the Liner between the pole and the taper region of the Shell.
- c. Drive the screw into the pilot hole by hand until the Liner is lifted out of the Shell (*Figure 19*).

**Special care should be taken not to damage the Shell taper or locking mechanism during removal of the Liner.*

SIZING GUIDE

ACETABULAR CUPS AND XLPE LINERS

 Cup Size (mm)		Liner Type	 Head Size (mm)			
			28	32	36	40
44 46	A	Neutral	01-041-01-0028			
		20° Hooded	01-041-05-0028			
		Lateralized 20° Hooded	01-041-06-0028			
		Constrained				
48	B	Neutral	01-041-01-0128	01-041-01-0132		
		20° Hooded	01-041-05-0128	01-041-05-0132		
		Lateralized 20° Hooded	01-041-06-0128	01-041-06-0132		
		Constrained	01-041-07-0128			
50 52 54	C	Neutral		01-041-01-0232	01-041-01-0236	
		20° Hooded		01-041-05-0232	01-041-05-0236	
		Lateralized 20° Hooded		01-041-06-0232	01-041-06-0236	
		Constrained		01-041-07-0232		
56 58	D	Neutral			01-041-01-0436	01-041-01-0440
		20° Hooded			01-041-05-0436	01-041-05-0440
		Lateralized 20° Hooded			01-041-06-0436	01-041-06-0440
		Constrained			01-041-07-0436	
60 62 64 66 68	E	Neutral			01-041-01-0536	01-041-01-0540
		20° Hooded			01-041-05-0536	01-041-05-0540
		Lateralized 20° Hooded			01-041-06-0536	01-041-06-0540
		Constrained				01-041-07-0540

INSTRUMENT LISTING

CATALOG NUMBER PART DESCRIPTION

112-152-306 Hi Torque Screwdriver 3.5mm Hex

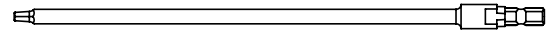

112-152-017 Drill Guide

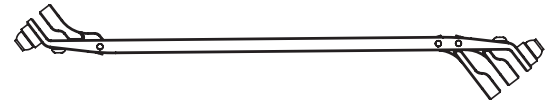

112-152-032 Depth Gauge



112-152-038 Screw Inserter

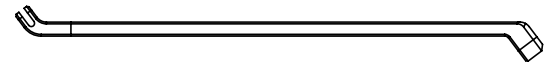

112-25-1666 Screw Holding Forceps

192-20-0162 Ratchet Driver (Blue Handle)



INSTRUMENT LISTING

CATALOG NUMBER PART DESCRIPTION

T17801	Acetabular Reamer, 44mm
T17802	Acetabular Reamer, 45mm
T17803	Acetabular Reamer, 46mm
T17804	Acetabular Reamer, 47mm
T17805	Acetabular Reamer, 48mm
T17806	Acetabular Reamer, 49mm
T17807	Acetabular Reamer, 50mm
T17808	Acetabular Reamer, 51mm
T17809	Acetabular Reamer, 52mm
T17810	Acetabular Reamer, 53mm
T17811	Acetabular Reamer, 54mm
T17812	Acetabular Reamer, 55mm
T17813	Acetabular Reamer, 56mm
T17814	Acetabular Reamer, 57mm
T17815	Acetabular Reamer, 58mm
T17816	Acetabular Reamer, 59mm
T17817	Acetabular Reamer, 60mm
T17818	Acetabular Reamer, 61mm
T17819	Acetabular Reamer, 62mm
T17820	Acetabular Reamer, 63mm
T17821	Acetabular Reamer, 64mm
T17823	Acetabular Reamer, 66mm
T17825	Acetabular Reamer, 68mm

112-152-191	Trial Acetabular Cup, 44mm
112-152-192	Trial Acetabular Cup, 46mm
112-152-193	Trial Acetabular Cup, 48mm
112-152-573	Trial Acetabular Cup, 50mm
112-152-195	Trial Acetabular Cup, 52mm
112-152-196	Trial Acetabular Cup, 54mm
112-152-197	Trial Acetabular Cup, 56mm
112-152-198	Trial Acetabular Cup, 58mm
112-152-199	Trial Acetabular Cup, 60mm
112-152-200	Trial Acetabular Cup, 62mm
112-152-201	Trial Acetabular Cup, 64mm
112-152-202	Trial Acetabular Cup, 66mm
112-152-203	Trial Acetabular Cup, 68mm

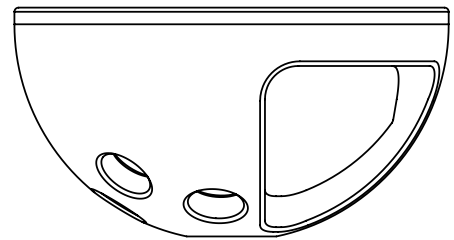
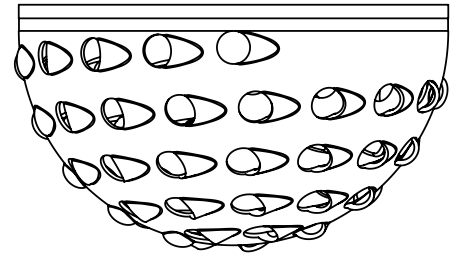

CATALOG NUMBER PART DESCRIPTION

112-152-156 Trial Liner Neutral, 28/44-46mm
 112-152-157 Trial Liner Neutral, 28/48mm
 112-152-159 Trial Liner Neutral, 32/48mm
 112-152-160 Trial Liner Neutral, 32/50-54mm
 112-152-163 Trial Liner Neutral, 36/50-54mm
 112-152-164 Trial Liner Neutral, 36/56-58mm
 112-152-165 Trial Liner Neutral, 36/60-70mm
 112-152-166 Trial Liner Neutral, 40/56-58mm
 112-152-167 Trial Liner Neutral, 40/60-70mm

A
B
B
C
C
D
E
D
E

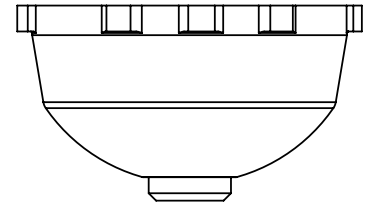

112-152-517 Trial Liner 20° Hooded, 28/44-46mm
 112-152-518 Trial Liner 20° Hooded, 28/48mm
 112-152-520 Trial Liner 20° Hooded, 32/48mm
 112-152-521 Trial Liner 20° Hooded, 32/50-54mm
 112-152-524 Trial Liner 20° Hooded, 36/50-54mm
 112-152-525 Trial Liner 20° Hooded, 36/56-58mm
 112-152-526 Trial Liner 20° Hooded, 36/60-68mm
 112-152-527 Trial Liner 20° Hooded, 40/56-58mm
 112-152-528 Trial Liner 20° Hooded, 40/60-68mm

A
B
B
C
C
D
E
D
E

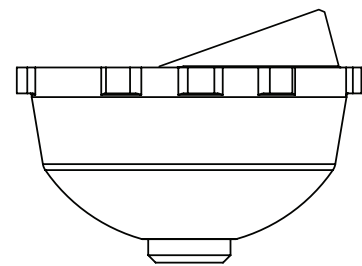

112-15-9844 Lateralized Trial Liner 20° Hooded, 28/44-46mm
 112-15-9850 Lateralized Trial Liner 20° Hooded, 28/48mm
 112-15-9250 Lateralized Trial Liner 20° Hooded, 32/48mm
 112-15-9252 Lateralized Trial Liner 20° Hooded, 32/50-54mm
 112-15-9652 Lateralized Trial Liner 20° Hooded, 36/50-54mm
 112-15-9656 Lateralized Trial Liner 20° Hooded, 36/56-58mm
 112-15-9660 Lateralized Trial Liner 20° Hooded, 36/60-68mm
 112-15-9456 Lateralized Trial Liner 20° Hooded, 40/56-58mm
 112-15-9460 Lateralized Trial Liner 20° Hooded, 40/60-68mm

A
B
B
C
C
D
E
D
E

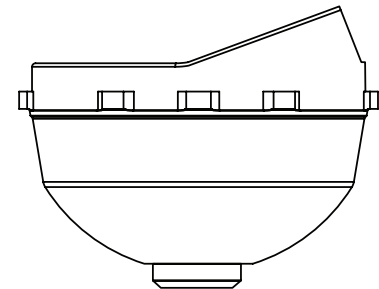

112-152-538 Constrained Trial Liner, 28/48mm
 112-152-539 Constrained Trial Liner, 32/50-54mm
 112-152-540 Constrained Trial Liner, 36/56-58mm
 112-152-541 Constrained Trial Liner, 40/60-68mm

B
C
D
E

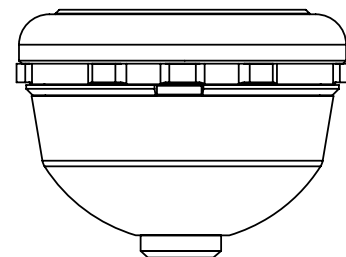

INSTRUMENT LISTING

CATALOG NUMBER PART DESCRIPTION

112-152-630 Alpha Straight Cup Inserter (Blue Handle)



112-152-018 Slim Reamer Shaft Assembly
(Slim grip 112-152-022)

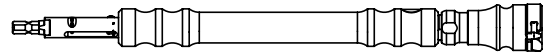

192-072-020 Optimus Q Drill (Flexible Drill)
(Drill bits 192-072-013)

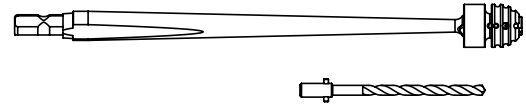

112-152-780 Offset Reamer Handle (Blue Handle)

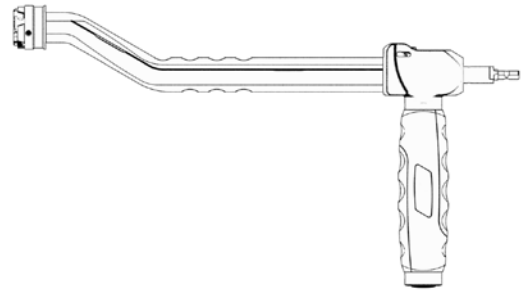

4250-7050 Offset Reamer Handle

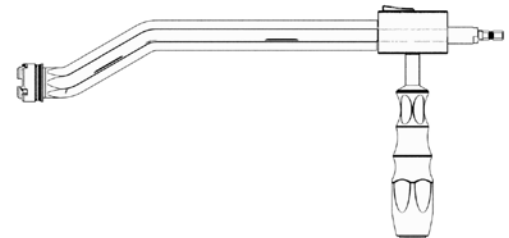

112-172-910 Curved Inserter Assembly (Blue Handle)



4252-2060 Offset Cup Impactor
4252-2092 Offset Cup Impactor (OCI Trinket)

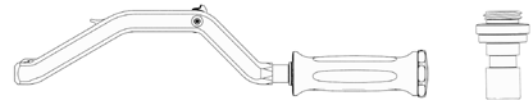

112-172-911 X8 Locking Driver (Blue Handle)



112-152-399 Acetal Liner Impactor, 28mm
112-152-400 Acetal Liner Impactor, 32mm
112-152-401 Acetal Liner Impactor, 36mm
112-152-402 Acetal Liner Impactor, 40mm

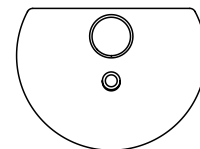

CATALOG NUMBER PART DESCRIPTION

01-040-95-0000 Templates, 44-68mm

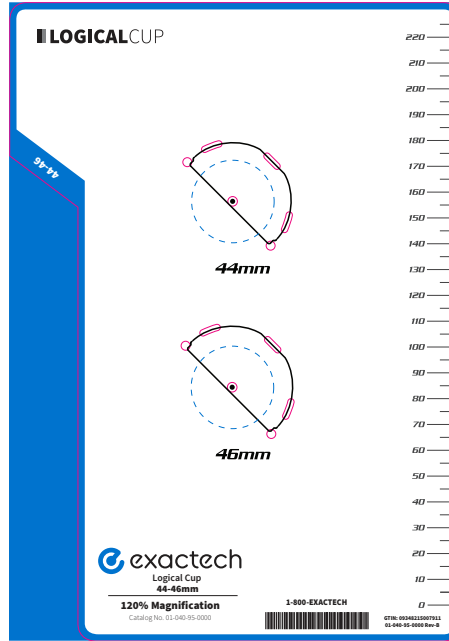

IMPLANTS LISTING

CATALOG NUMBER

PART DESCRIPTION

01-040-01-0044	G Series Acetabular Cup, 2 Holes, 44mm
01-040-01-0046	G Series Acetabular Cup, 2 Holes, 46mm
01-040-01-0148	G Series Acetabular Cup, 3 Holes, 48mm
01-040-01-0250	G Series Acetabular Cup, 3 Holes, 50mm
01-040-01-0252	G Series Acetabular Cup, 3 Holes, 52mm
01-040-01-0254	G Series Acetabular Cup, 3 Holes, 54mm
01-040-01-0456	G Series Acetabular Cup, 3 Holes, 56mm
01-040-01-0458	G Series Acetabular Cup, 3 Holes, 58mm
01-040-01-0560	G Series Acetabular Cup, 3 Holes, 60mm
01-040-01-0562	G Series Acetabular Cup, 3 Holes, 62mm
01-040-01-0564	G Series Acetabular Cup, 3 Holes, 64mm
01-040-01-0566	G Series Acetabular Cup, 3 Holes, 66mm
01-040-01-0568	G Series Acetabular Cup, 3 Holes, 68mm

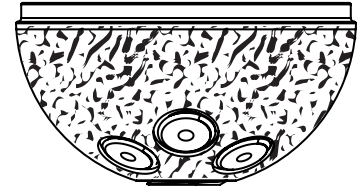

01-041-01-0028	XLPE Liner Neutral, 28/44-46mm
01-041-01-0128	XLPE Liner Neutral, 28/48mm
01-041-01-0132	XLPE Liner Neutral, 32/48mm
01-041-01-0232	XLPE Liner Neutral, 32/50-54mm
01-041-01-0236	XLPE Liner Neutral, 36/50-54mm
01-041-01-0436	XLPE Liner Neutral, 36/56-58mm
01-041-01-0536	XLPE Liner Neutral, 36/60-68mm
01-041-01-0440	XLPE Liner Neutral, 40/56-58mm
01-041-01-0540	XLPE Liner Neutral, 40/60-68mm

A
B
B
C
C
D
E
D
E

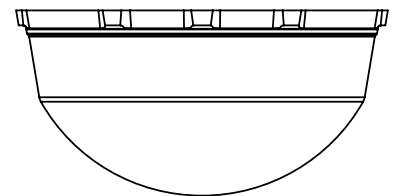

01-041-05-0028	XLPE Liner 20° Hooded*, 28/44-46mm
01-041-05-0128	XLPE Liner 20° Hooded*, 28/48mm
01-041-05-0132	XLPE Liner 20° Hooded*, 32/48mm
01-041-05-0232	XLPE Liner 20° Hooded*, 32/50-54mm
01-041-05-0236	XLPE Liner 20° Hooded*, 36/50-54mm
01-041-05-0436	XLPE Liner 20° Hooded*, 36/56-58mm
01-041-05-0536	XLPE Liner 20° Hooded*, 36/60-68mm
01-041-05-0440	XLPE Liner 20° Hooded*, 40/56-58mm
01-041-05-0540	XLPE Liner 20° Hooded*, 40/60-68mm

A
B
B
C
C
D
E
D
E

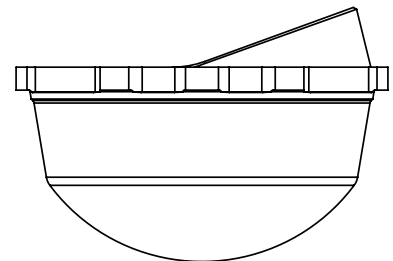

01-041-06-0028	XLPE Liner 20° Hooded Lateralized* (+4mm), 28/44-46mm
01-041-06-0128	XLPE Liner 20° Hooded Lateralized* (+4mm), 28/48mm
01-041-06-0132	XLPE Liner 20° Hooded Lateralized* (+4mm), 32/48mm
01-041-06-0232	XLPE Liner 20° Hooded Lateralized* (+4mm), 32/50-54mm
01-041-06-0236	XLPE Liner 20° Hooded Lateralized* (+4mm), 36/50-54mm
01-041-06-0436	XLPE Liner 20° Hooded Lateralized* (+4mm), 36/56-58mm
01-041-06-0536	XLPE Liner 20° Hooded Lateralized* (+4mm), 36/60-70mm
01-041-06-0440	XLPE Liner 20° Hooded Lateralized* (+4mm), 40/56-58mm
01-041-06-0540	XLPE Liner 20° Hooded Lateralized* (+4mm), 40/60-68mm

A
B
B
C
C
D
E
D
E

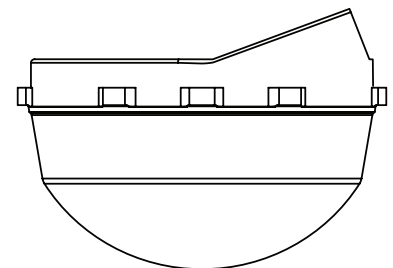

*USA Only

CATALOG NUMBER

PART DESCRIPTION

01-041-07-0128	XLPE Liner Constrained, 28/48mm
01-041-07-0232	XLPE Liner Constrained, 32/50-54mm
01-041-07-0436	XLPE Liner Constrained, 36/56-58mm
01-041-07-0540	XLPE Liner Constrained, 40/60-68mm
01-041-50-6515	Acetabular Fixation Screws, Ø6.5mm, 15mm
01-041-50-6520	Acetabular Fixation Screws, Ø6.5mm, 20mm
01-041-50-6525	Acetabular Fixation Screws, Ø6.5mm, 25mm
01-041-50-6530	Acetabular Fixation Screws, Ø6.5mm, 30mm
01-041-50-6535	Acetabular Fixation Screws, Ø6.5mm, 35mm
01-041-50-6540	Acetabular Fixation Screws, Ø6.5mm, 40mm
01-040-01-0000	Apical Screw

B
C
D
E

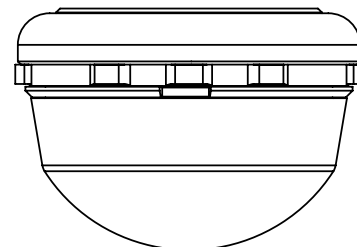

Exactech, Inc. is proud to have offices and distributors around the globe. For more information about Exactech products available in your country, please visit www.exac.com

For additional device information, refer to the manufacturer's Instructions for Use for a device description, indications, contraindications, precautions and warnings. For further product information, please contact Customer Service, Exactech, Inc., 2320 NW 66th Court, Gainesville, Florida 32653-1630, USA. (352) 377-1140, (800) 392-2832 or FAX (352) 378-2617.

Exactech, as the distributor of this device, does not practice medicine, and is not responsible for recommending the appropriate surgical technique for use on a particular patient. These are intended to be solely informational and each surgeon must evaluate the appropriateness of these guidelines based on his or her personal medical training and experience. Prior to use of this system, the surgeon should refer to the product package insert for comprehensive warnings, precautions, indications for use, contraindications and adverse effects.

The products discussed herein may be available under different trademarks in different countries. All trademarks used herein are registered or common law trademarks of Blue Ortho or Exactech, Inc. This material is intended for the sole use and benefit of the Exactech sales force and physicians. It should not be redistributed, duplicated or disclosed without the express written consent of Exactech, Inc. Copyright in all aspects of these materials is owned by Blue Ortho and/or Exactech, Inc., ©2022. 00-0002670 Rev A 0722



EXACTECH, INC.
2320 NW 66TH COURT
GAINESVILLE, FL 32653 USA

+1 352.377.1140
+1 800.EXACTECH
+1 352.378.2617 (FAX)
www.exac.com