

EXACTECH | EXTREMITIES

Operative Technique Addendum

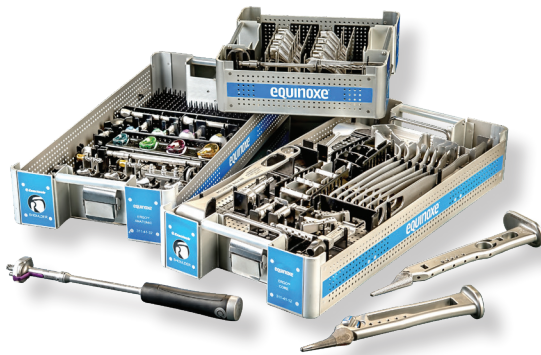

equinox

**Equinox Laser Cage with Ergo
Instrumentation Operative Technique**

TABLE OF CONTENTS

EQUINOXE LASER CAGE GLENOID OVERVIEW	2
GLENOID EXPOSURE/ASSESSMENT	3
CANNULATED OR PILOT-TIP METHOD OVERVIEW	4
MODULAR aTSA REAMER PILOTTIP OR CANNULATED	4
OPTION ONE: 0-DEGREE LASER CAGE GLENOID	6
CANNULATED DRILLING WITH GUIDE & REAMING	6
CANNULATED OR PILOT-TIP - DRILLING CENTRAL CAGE HOLE.....	8
GLENOID TRIALING	9
DRILLING FOR PERIPHERAL PEGS	9
CEMENTING THE GLENOID	10
FINAL 0-DEGREE GLENOID IMPLANTATION	10
OPTION TWO: 8-DEGREE GLENOID – POSTERIOR AUGMENT	12
8-DEGREE GLENOID SUGGESTED USAGE.....	12
8-DEGREE GLENOID CANNULATED OFF-AXIS REAMING	13
CANNULATED OFF-AXIS REAMING	14
PILOTTIP - 8-DEGREE OFF-AXIS REAMING.....	15
CANNULATED - 8-DEGREE DRILLING CENTRAL CAGE HOLE	16
REMOVING THE CAGE GLENOID	19
FULL CAGE/PEG DEPTH DRILLING	19
POLY DEPTH DRILLING	20
IMPLANT & INSTRUMENT LISTING.....	21
REVISION & DISPOSABLE INSTRUMENTS LISTING.....	22
INSTRUMENT LISTING	23
SYSTEM SPECIFICATIONS	25



DESIGN TEAM SURGEONS

Stephen Brockmeier, MD

*University of Virginia Health System
Charlottesville, VA*

Pierre-Henri Flurin, MD

*Surgical Clinic of Bordeaux
Merignac, France*

Sean Grey, MD

*Orthopaedic & Spine Center of the Rockies
Fort Collins, CO*

Brad Schoch, MD

*Mayo Clinic
Jacksonville, FL*

Thomas W. Wright, MD

*University of Florida
Gainesville, FL*

Joseph D. Zuckerman, MD

*NYU Langone Orthopedic Hospital
New York, NY*

EQUINOXE LASER CAGE GLENOID OVERVIEW

0-DEGREE & 8-DEGREE LASER CAGE GLENOID OPTIONS & HUMERAL HEAD RADIAL MISMATCH



**0-Degree
Glenoid**

**8-Degree
Glenoid**

Table 1

EQUINOXE HUMERAL HEAD RADIAL MISMATCH ASSOCIATED WITH GLENOID/HUMERAL HEAD PAIRING

Humeral Head Sizes (Coverage Diameter x Height)

<i>Short Humeral Head (Curvature Diameter x Height)</i>	38x16mm	41x16mm	44x17mm	47x18mm	50x19mm	53x20mm
<i>Tall Humeral Head (Curvature Diameter x Height)</i>	38x19mm	41x20mm	44x21mm	47x22mm	50x23mm	53x24mm
<i>Expanded Humeral Head (Curvature Diameter x Height)</i>	N/A	N/A	N/A	47x26mm	50x27mm	53x28mm

<i>Glenoid Type</i>	<i>Sizes</i>	<i>Radius of Curvature</i>						
Standard (Cage and All Poly)	Small, Medium, Large	27mm (Alpha)	7.72	5.86	4.26	2.66	1.05	-0.56
	Medium, Large, X-Large	31mm (Beta)	11.72	9.86	8.26	6.66	5.05	3.44
Posterior Augment (Cage and All Poly)	Small	27.55mm	8.27	6.41	4.81	3.21	1.60	-0.01
	Medium	29.7mm	10.42	8.56	6.96	5.36	3.75	2.14
	Large/X- Large	31.85mm	12.57	10.71	9.11	7.51	5.90	4.29
			<i>Recommended Head/Glenoid Pairing</i>			<i>Acceptable Head/Glenoid Pairing</i>		

■ Not recommended

Glenoid Exposure

Retractors are provided to aid in glenoid exposure. A posterior glenoid retractor should be used to displace the proximal humerus posteriorly (i.e. Wolfe Retractor/Humeral Head Retractor, Dual Point Glenoid Retractor). Hohmann Retractors are placed superiorly and inferiorly around the glenoid.

The glenoid labrum is excised and an anterior and inferior capsular release is performed both for exposure and soft tissue mobilization. A formal posterior capsular release is only performed if adequate glenoid exposure cannot be obtained or if limitation of internal rotation is identified as a significant problem.

Some surgeons prefer to resect the biceps insertion and perform a biceps tenodesis. Biceps release and tenodesis will also enhance glenoid exposure. At this point, the degree and location of glenoid erosion can be visualized.

Note: *Some key steps to adequate glenoid exposure are as follows:*

- 1) Fully mobilize subdeltoid space
- 2) Release inferior capsule completely off the humerus by externally rotating humerus
- 3) Release anterior capsule and subscapularis from glenoid
- 4) Excise labrum and release anterior and inferior capsule (protect axillary nerve)
- 5) Resect adequate amount of humerus
- 6) Stretch posterior capsule with humeral head retractor pushing humerus posterior to the glenoid
- 7) Biceps release with excision of superior labrum will also assist with glenoid exposure
- 8) If exposure is not adequate after steps 1-7, release posterior inferior capsule and triceps origin (must isolate and retract axillary nerve for this procedure)
- 9) If still poor exposure (very rare), then a posterior capsule release should be performed.

Assessing Glenoid Version

Glenoid wear requires special consideration. With increasing posterior glenoid erosion, posterior humeral head subluxation occurs with secondary stretching of the posterior capsule. Options to treat this asymmetric wear include, most commonly, reaming eccentrically to lower the high (non-worn) side or using augmented glenoids to build up the worn side. In very severe cases, bone grafting to elevate the low (worn) side may also be another option. Additionally, the surgeon will

have the opportunity to modify the humeral head version on the humeral side by up to 7.5 degrees with the replicator plate if additional stability is required if using a platform stem.

Pre-operative planning is also available, which allows surgeons to use a 3D rendering of the patient's scapula to plan their case before surgery. Additionally, interoperative navigation is available utilizing ExactechGPS.

If the glenoid bone is inadequate (an uncommon occurrence), hemiarthroplasty should be performed with glenoid shaping to provide a concave surface for the humeral head.

Choosing the Glenoid

The Equinox System provides caged, all-poly pegged, and posterior augment glenoid options (details for all-poly pegged glenoids and posterior augment pegged glenoids can be found in operative techniques 718-01-30 and 718-01-32, respectively). The specific glenoid chosen should be based on surgeon preference and the patient's anatomy. For the medium and large glenoids, two articular curvatures are provided (alpha and beta) so that these sized glenoids can be matched with any size humeral head component (38mm -53mm) while at the same time obtaining an optimal radial mismatch (average 5.5mm). This is accomplished by choosing an alpha or beta glenoid based upon the humeral head diameter. The small glenoids are only provided in the alpha curvature. The extra-large glenoid is only provided in the beta curvature (*Table 1*).

NOTE: *The Equinox Laser Cage Glenoid implants are inserted using steps included in this operative technique. The Laser Cage Glenoid operative technique presents an addendum to the Equinox Platform Shoulder System, and the Equinox Platform Shoulder System with Ergo Instruments operative techniques to include the Equinox Laser Cage Glenoid.^{1,2}*

Please refer to the anatomic shoulder section of the Equinox Platform Shoulder System operative techniques for information related to patient positioning, surgical approaches, and the preparation of the humerus and glenoid.^{1,2} The steps described in this addendum address the specific 0-degree and 8-degree Laser Cage Glenoid implantation and revision steps.

CANNULATED OR PILOT-TIP METHOD OVERVIEW

MODULAR ATSA REAMER | PILOT TIP OR CANNULATED



Figure 1
Modular aTSA Reamer and Pilot Tip Driver



Figure 2
Modular aTSA Reamer and Cannulated
Glenoid Reamer Driver

MODULAR aTSA REAMER | PILOT TIP OR CANNULATED

The Equinox primary system provides two options to ream the glenoid:

- 1) **Pilot Tip Glenoid Reaming** (Figure 1)
- 2) **Cannulated Glenoid Reaming** (Figure 2)

The Pilot Tip Reaming technique has a rounded-pilot tip driver, which provides the surgeon greater angular adjustability and thereby facilitates eccentric reaming.

Cannulated Reamers rotate on 3.2mm K-wire and provide the surgeon with more control. The Modular Anatomic Reamer attaches to either the **Pilot Tip Glenoid Reamer Driver (315-50-11)** or the **Cannulated Glenoid Reamer Driver (315-50-12)** by pulling back the black sleeve on the driver and inserting the appropriate reamer into the driver.

Note: Verify that the reamer is attached to the Reamer Driver before reaming.

Note: Avoid applying a bending force to the Reamer Driver (e.g. using the Reamer Driver to assist with exposure). This could lead to fracture of the pilot tip or 3.2mm K-wire.

Regardless of the reaming option, the first step is to identify the center of the glenoid (the point where the superior/inferior and anterior/posterior glenoid axes intersect); ensure that all glenoid osteophytes have been removed so that the true center of the glenoid can be accurately identified. Glenoid sizers (small, medium, large, and extra-large) are provided that correspond to the various size glenoid implants and can assist with choosing a size that best matches the articular surface of the glenoid.

OPERATIVE TECHNIQUE OVERVIEW

0-DEGREE GLENOID OPERATIVE TECHNIQUE

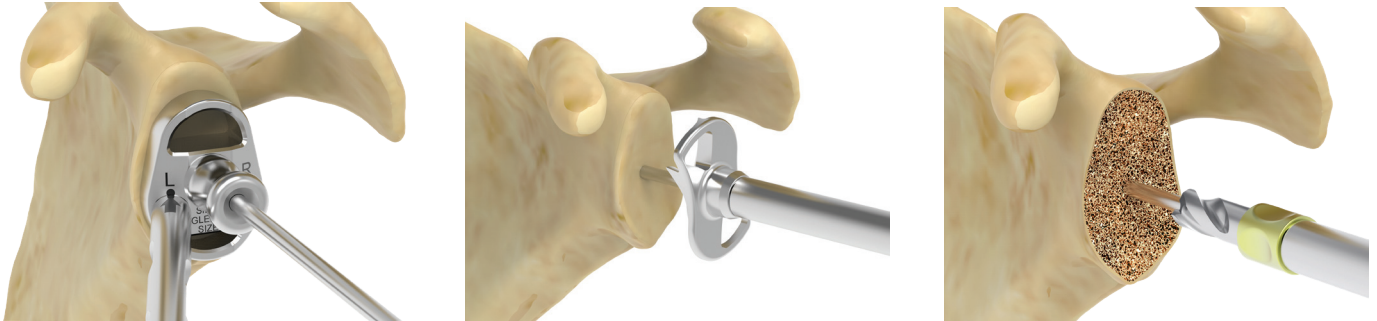

Figure A

Cannulated Option: Insert 3.2mm K-wire, Ream and Drill Center Hole Over K-wire

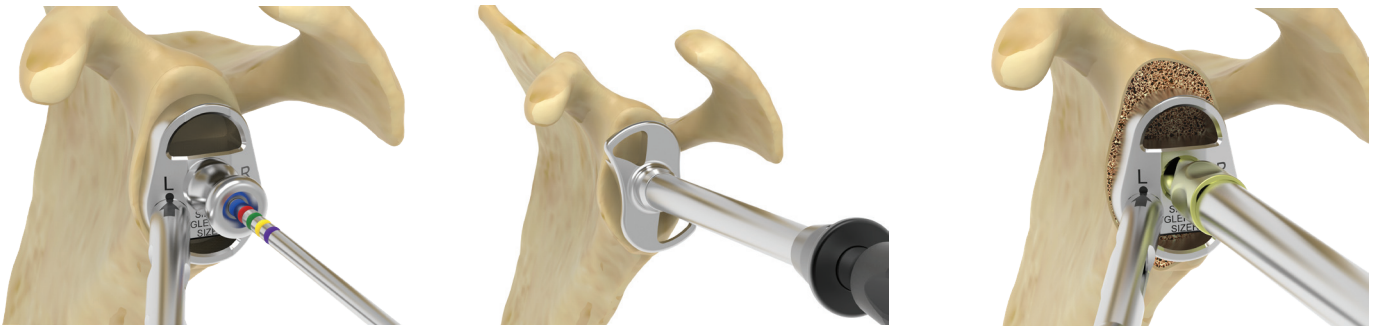

Figure B

Pilot Tip Option: Drill Center 3.2mm Pilot Hole, Ream the Glenoid and Drill Center Hole

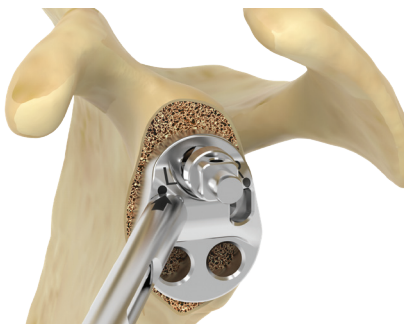

Figure C

Drill the Peripheral Holes

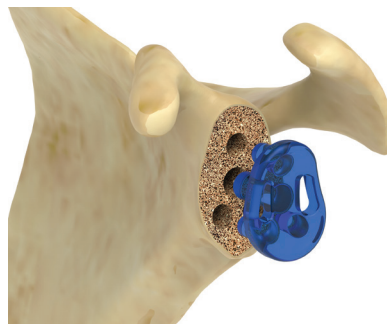

Figure D

Insert Trial Glenoid and Confirm Hole Depth

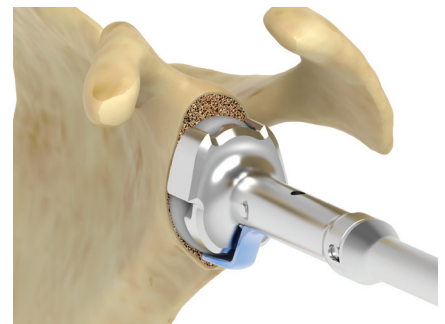

Figure E

Cement and Impact Final Glenoid

DETAILED OPERATIVE TECHNIQUE

CANNULATED DRILLING WITH GUIDE & REAMING

OPTION ONE: 0-Degree Laser Cage Glenoid

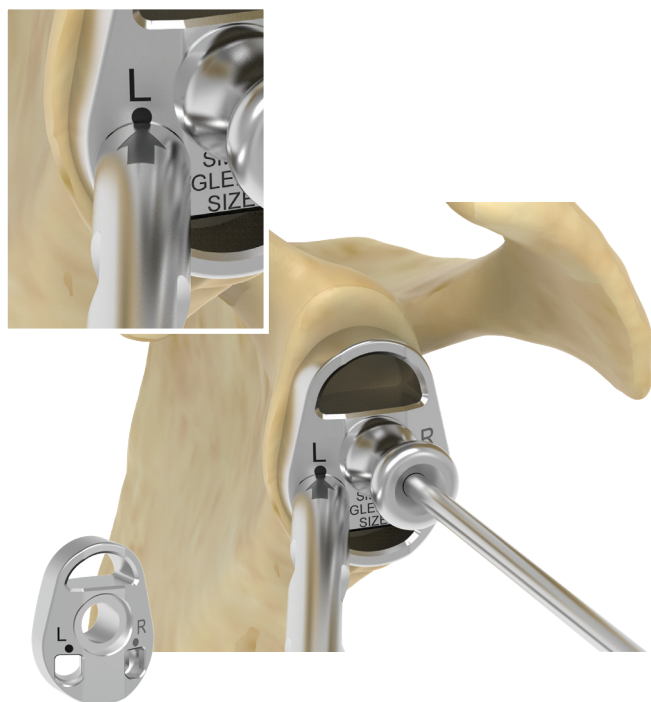

Figure 3
Insert 3.2mm K-Wire

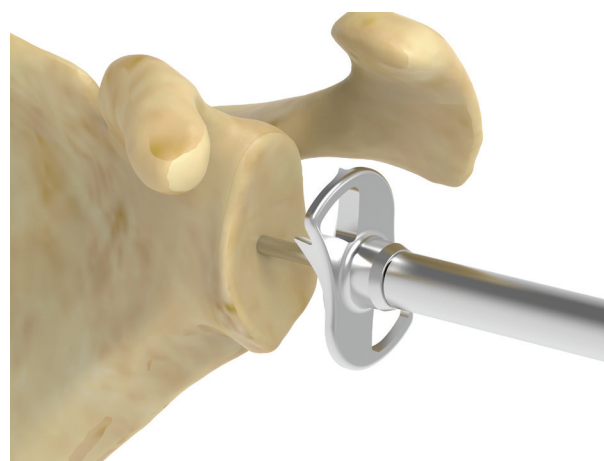

Figure 4
Ream the Glenoid

CANNULATED DRILLING WITH GUIDE & REAMING

Choose the appropriate **Glenoid Sizer (Small 315-56-02, Medium 315-56-03, Large 315-56-04, Extra Large 315-56-05)** and attach this to the **Modular Glenoid Guide Handle (315-52-11)** by matching the laser marking on both the **Glenoid Sizer** and **Handle (Figure 3)**. The same guide will be used for both left and right shoulders, as indicated by the L and R laser marks.

Note: Verify that the handle mechanism is locked on the Glenoid Sizer prior to inserting into the wound.

Snap the **K-Wire Adapter (315-51-10)** into the Glenoid Sizer, then the **3.2mm Trocar Tip K-Wire (321-52-09)** through the Glenoid Sizer and K-wire Adapter and carefully drill under power until the 3.2mm Trocar Tip K-Wire has engaged the medial cortex of the glenoid vault (*Figure 3*). Once the K-wire is securely placed, back the guide out over the pin and remove from the joint.

An **Extra-Small Modular aTSA Reamer (315-50-01)** is provided to aid the surgeon in the initial preparation. Connect the appropriately-sized **Modular aTSA Reamer (315-50-01,02,03,04,05)** to the **Cannulated Glenoid Reamer Driver (315-50-12)**.

Sequentially ream the glenoid over the K-wire to the appropriate size (*Figure 4*). If substantial posterior glenoid erosion is evident, augmented components are available to restore version and ensure the implant is fully supported.

Note: Avoid applying a bending force to the 3.2mm K-wire as this may cause a fracture.

Note: Check that the reamer or drill is engaged on the driver handle before starting.

Note: Start the reamer prior to engaging bone.

OPTION ONE: 0-Degree Laser Cage Glenoid

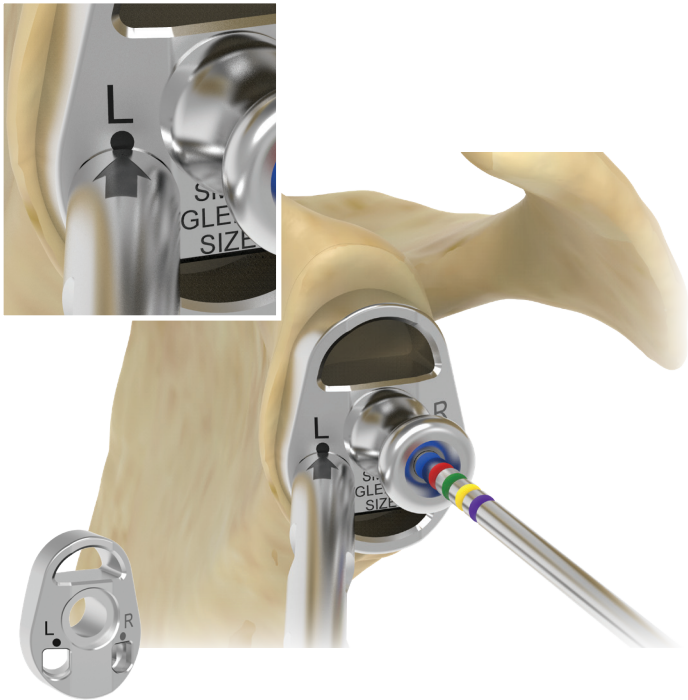

Figure 5
Drill 3.2mm Pilot Hole

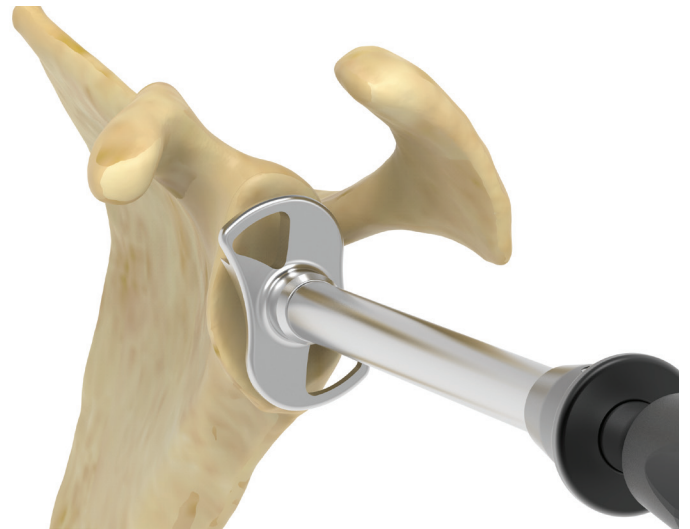

Figure 6
Ream the Glenoid

PILOT TIP DRILLING WITH GUIDE & REAMING

Choose the appropriate **Glenoid Sizer (Small 315-56-02, Medium 315-56-03, Large 315-56-04, Extra Large 315-56-05)** and attach this to the **Modular Glenoid Guide Handle (315-52-11)** by matching the laser marking on both the Glenoid Sizer and handle (*Figure 5*). The same guide will be used for both left and right shoulders, as indicated by the L and R laser marks.

Note: Verify that the handle mechanism is locked on the sizer prior to inserting into the wound.

If using the Pilot Tip procedure, start by drilling a 3.2mm hole using the **3.2mm Drill W/AO (321-52-07)** drill bit, **K-wire Adapter (315-51-10)** and selected Glenoid Sizer (*Figure 5*). It is suggested that the surgeon drill to at least the blue depth marking (30mm) when making the pilot tip hole.

An **Extra Small Modular aTSA Reamer (315-50-01)** is provided to aid the surgeon in the initial preparation. Connect the appropriately sized reamer to the **Pilot Tip Glenoid Reamer Driver (315-50-11)**.

Sequentially ream the glenoid to the appropriate size (*Figure 6*). If substantial posterior glenoid erosion is evident, augmented components are available to restore version and ensure the implant is fully supported.

Note: Check that the reamer or drill is engaged on the driver handle before starting.

DETAILED OPERATIVE TECHNIQUE

CANNULATED OR PILOT-TIP - DRILLING CENTRAL CAGE HOLE

OPTION ONE: 0-Degree Laser Cage Glenoid

Cannulated Method

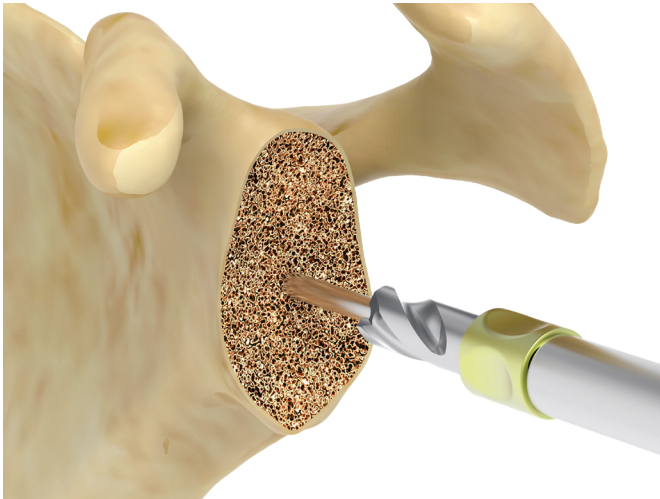

Figure 7

Cannulated - Drill Center Hole Over 3.2mm Steinmann Pin

Pilot-Tip Method

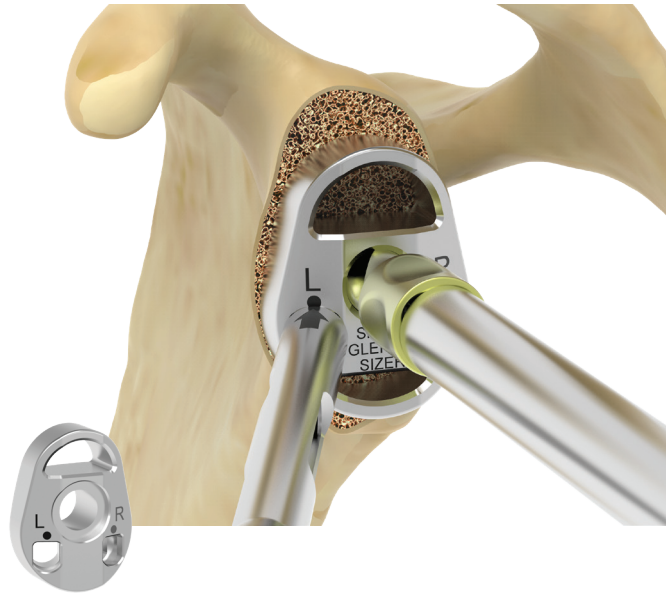

Figure 8

Pilot-Tip - Drill the Center Hole (Pilot Tip)

Note: Start the reamer prior to engaging bone.

DRILLING CENTRAL CAGE HOLE

Cannulated Drilling With K-Wire

If using the Cannulated Technique, connect the **Modular Cannulated Center Peg Drill (315-52-65)** to the **Cannulated Glenoid Reamer Driver (315-50-12)** and drill the center hole over the 3.2mm K-wire. Drill until the collar of the drill bit contacts the glenoid surface and is fully seated. Do not drill through Modular Center Peg Guide if using Cannulated Technique (Figure 7).

WARNING: Avoid applying a bending force to the 3.2mm Steinmann Pin as this may cause a fracture. Driver and drill bits should be removed by pulling straight back over the wire to prevent unnecessary bending.

Pilot Tip Drilling With Drill Guide

After reaming, if using the Pilot Tip method, connect the **Modular Central Peg Drill (315-52-64)** to the **Cannulated Glenoid Reamer Driver (315-50-12)** and drill center hole through the appropriate **Glenoid Sizer (Small 315-56-02, Medium 315-56-03, Large 315-56-04, Extra Large 315-56-05)** (Figure 8).

Note: Ensure that the central cage hole is drilled on-axis relative to the prepared glenoid. Off-axis drilling can lead to misaligned peg holes and prestress the poly/peg interfaces.

OPTION ONE: 0-Degree Laser Cage Glenoid

Size	Pegged Glenoid Trial Color
S	Blue
M	Green
L	Purple
XL	Yellow

Table 2
Glenoid Size Color Coded Trials

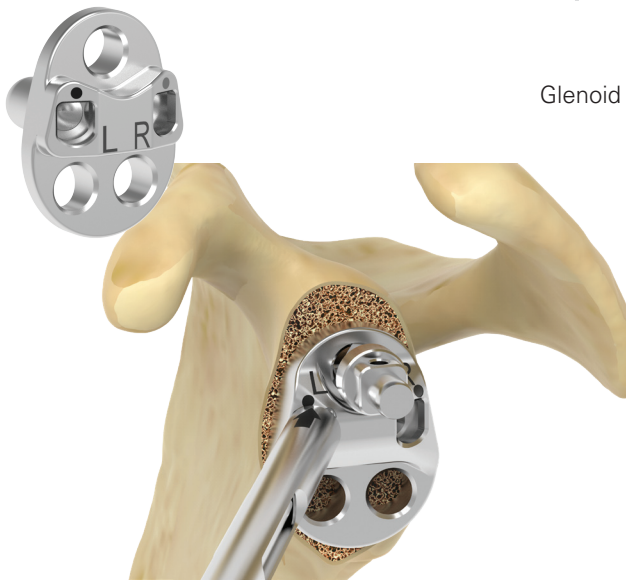

Figure 9
Drill the Peripheral Holes

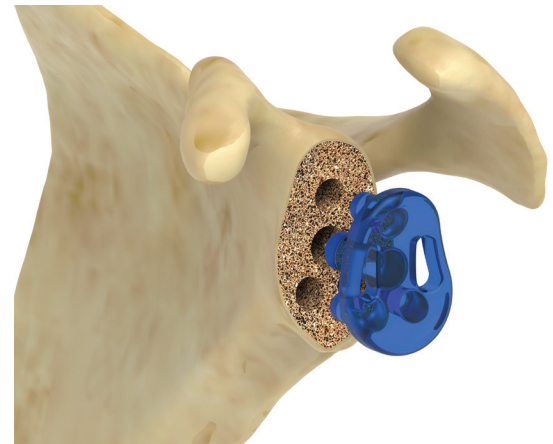

Figure 10
Insert Glenoid Trial

DRILLING FOR PERIPHERAL PEGS

Connect the Modular Glenoid Guide Handle to the **Peripheral Peg Drill Guide (315-52-62)** using the same method as attaching the Glenoid Sizers and place it into the prepared glenoid. Connect the **Modular Peripheral Peg Drill (315-52-62)** to the **Peripheral Peg Driver (315-52-01)** and drill the three peripheral holes through the **Peripheral Peg Drill Guide (315-57-04)** (Figure 9).

Note: Avoid levering on the Peripheral Peg Drill guide after drilling.

When drilling the peripheral peg holes, the Modular Peripheral Peg Drill will release and act as the holding pin for the Peripheral Hole Drill Guide, as needed.

Note: Ensure that the peripheral peg holes are drilled on-axis relative to the central cage hole. Off-axis drilling can lead to misaligned peg holes and prestress the poly/peg interfaces.

GLENOID TRIALING

After drilling the peripheral holes, and removing the drills and drill guide, use the **Pegged Glenoid Trial (Small 315-53-02, Medium 315-53-03, Large 315-53-04, Extra Large 315-53-05)** to ensure correct coverage as well as to check that the holes were prepared to the defined depth (Figure 10). If the Pegged Glenoid Trial is not fully seated, redrill holes as needed.

Note: Pegged Glenoid Trials were designed to fit conveniently in Allis clamps or forceps for easy insertion/removal.

Since the peg pattern/spacing is the same on all sizes, the surgeon may easily upsize or downsize the cage glenoid to achieve the best coverage (provided that all the cortical bone was reamed).

Note: Trials are color-coded (Table 2).

DETAILED OPERATIVE TECHNIQUE

CEMENTING THE GLENOID /FINAL 0-DEGREE GLENOID IMPLANTATION

OPTION ONE: 0-Degree Laser Cage Glenoid

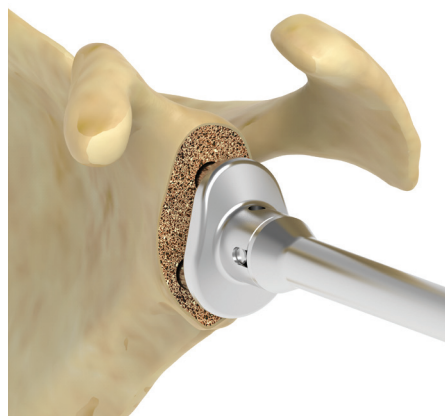

Figure 11
Pressurize the
Cement

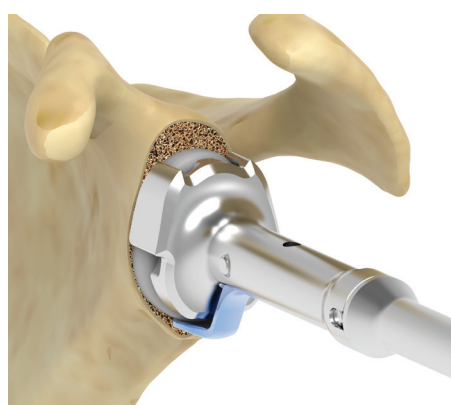
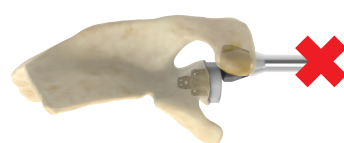

Figure 12
Impact Cage Glenoid
Component Using
the Appropriately
Sized aTSA Glenoid
Impactor



Off-Center Impaction



Off-Axis Impaction



Off-Axis & Off-Center Impaction



On-Axis Impaction

CEMENTING THE GLENOID

Prepare the glenoid by first copiously irrigating the holes to clear any debris. Cement should be placed in each of the peripheral drilled peg holes. After placing cement, the **Cement Pressurizer Peripheral Pegs (315-57-08)** should be used to pressurize the cement in the glenoid (Figure 11). A second injection of cement with thumb pressurization is then completed.

FINAL 0-DEGREE GLENOID IMPLANTATION

The glenoid component is then seated using the correct size **aTSA Glenoid Impactor (Small 315-55-02, Medium 315-55-03, Large 315-55-04, X-Large 315-55-04)** (Figure 12). Each Impactor is color-coded to match their corresponding glenoid trial. Ensure the aTSA Glenoid Impactor is fully assembled to the **Modular Impactor Handle (321-09-05)** or **Impactor Handle (321-07-05)** before striking.

WARNING: Don't assemble or disassemble devices in the surgical field.

Note: Ensure straight line visibility for cage insertion.

Note: Only impact the glenoid component in the center of the articular surface on-axis with the central cage, ensuring the impactor tip remains assembled throughout the insertion process. Do not impact off-axis and/or off-center as shown in Figure 12 above as this can lead to damage to the poly/peg interfaces.

Strike the glenoid impactor with a mallet to ensure that the glenoid component is in complete contact with the bone. Apply firm, steady digital pressure on the glenoid until polymerization is complete. Run a small elevator around the edge of the glenoid component to ensure there is no interposed soft tissue. Excess cement around the edges of the glenoid implant is removed before the cement polymerizes.

Note: When inserting the final implant, keep the inserter pointed up with a hand underneath until the implant is in the wound.



Determining Retroversion

Figure A
Preoperative Retroversion, Glenoid Center, and Establishing Neutral Axis

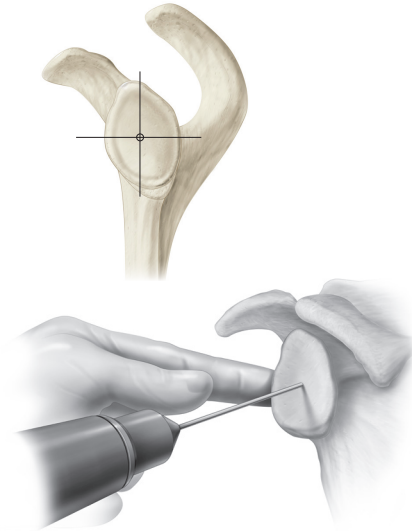
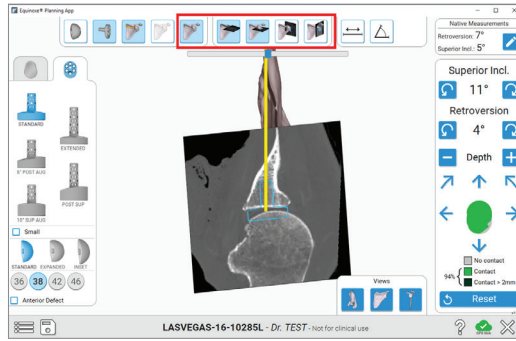

Finding 8-Degree - Freehand or with Drill Guide Method

Figure B
Finding 8-degree with Freehand Method, Establishing Neutral Axis, Finding 8-degree with Freehand Method or Finding 8-degree Axis with Drill Guide

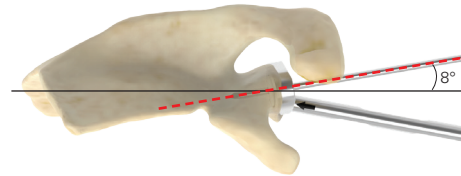

Pilot Tip or Cannulated Off Axis Reaming

Figure C
Cannulated Reaming or Pilot Tip Reaming

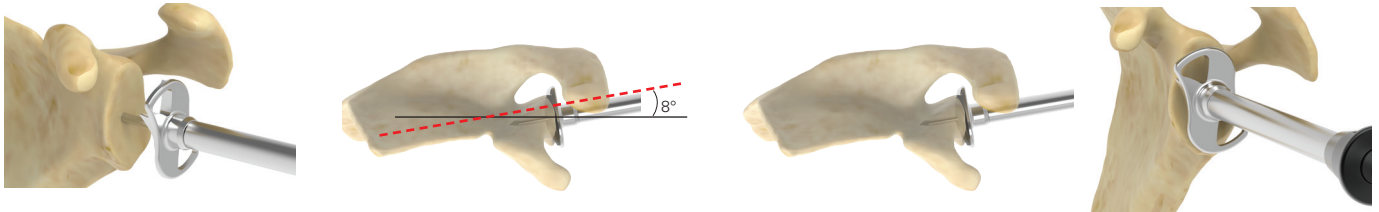

Drilling for Central Cage & Peripheral Pegs

Figure D
Cannulated Central Cage Drilling or Pilot Tip, Drilling Peripheral Pegs, Trialing and Pressurizing Cement



Figure E
Implanting Final Augmented Laser Cage Glenoid

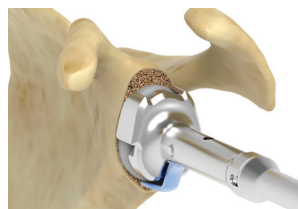

OPTION TWO: 8-Degree Glenoid – Posterior Augment



Figure 13
Posterior Augment Glenoid

8-DEGREE GLENOID SUGGESTED USAGE

The **8-Degree Posterior Augment Laser Cage Glenoid, (LEFT 314-24-22,23,24 / RIGHT 314-24-25,32,33,34,35)** is designed to minimize the removal of anterior cortical bone when reaming a posteriorly worn glenoid to correct its version (*Figure 13*), assuming the patient has posterior wear and the surgeon wants to correct the glenoid back to neutral version.

Note: *Posterior Augment Glenoids can be used to treat anterior glenoid defects by using the opposite side implant. For example, treat a right anterior defect using a left Posterior Augment Glenoid implant.*

OPTION TWO: 8-Degree Glenoid – Posterior Augment

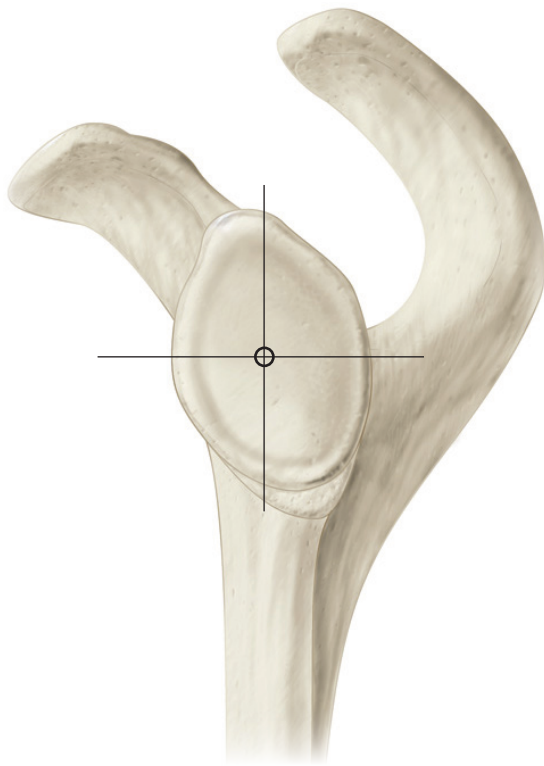

Figure 14
Determining Glenoid Center

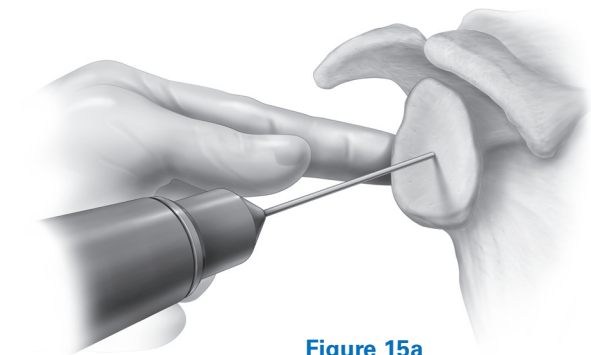

Figure 15a
Matsen's Point

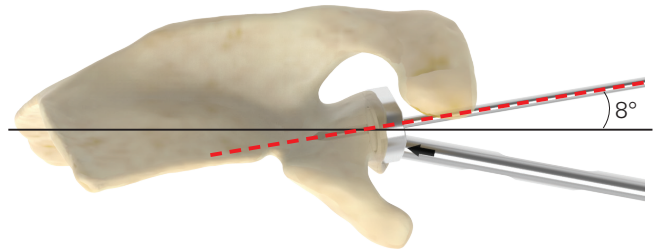

Figure 15b
Off-Axis Reaming Angle

8-DEGREE GLENOID CANNULATED OFF-AXIS REAMING

Determining Preoperative Retroversion

Utilize the **Equinox® Planning App** to determine preoperative retroversion and desired amount of correction.

Glenoid Center

Identify the center of the glenoid (the point where the superior/inferior and anterior/posterior glenoid axes intersect); ensure that all glenoid osteophytes have been removed so that the true center of the glenoid can be accurately identified (*Figure 14*).

Establishing Neutral Axis

Once the center has been determined, establish a neutral axis via Matsen's point (*Figure 15a*).

Finding 8-Degree with Freehand Method

The neutral axis has been established, insert k-wire at desired reaming axis for posterior bone loss, taking into account the 8-degree augment angle correction.

Finding 8-Degree Axis With Drill Guide

Placing the non-augmented glenoid guide perpendicular to the worn glenoid surface can help determine the appropriate angle if Matsen's point is not able to be established (*Figure 15b*).

Choose the appropriate **Glenoid Sizer (Small 315-56-02, Medium 315-56-03, Large 315-56-04, Extra Large 315-56-05)**; the same guide will be used for both left and right shoulders, as indicated by the L and R laser marks. Snap the K-Wire Adapter into the appropriate Sizer and insert the K-wire.

OPTION TWO: 8-Degree Glenoid – Posterior Augment

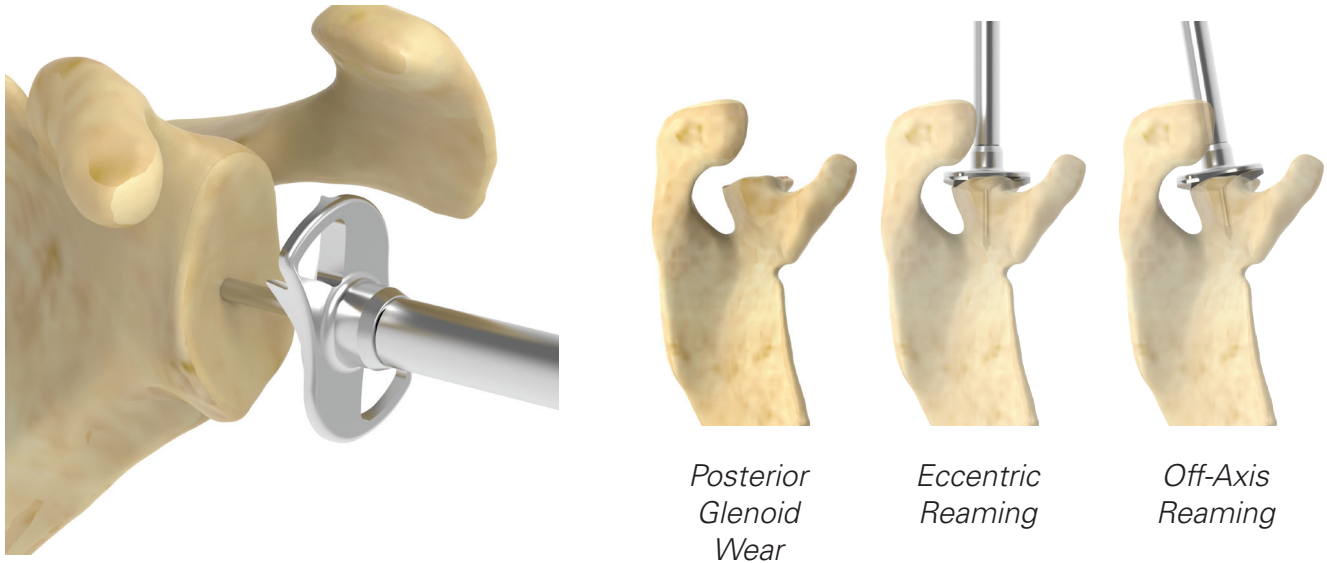

Figure 16
Ream the Glenoid

CANNULATED OFF-AXIS REAMING

Reaming The Glenoid

An Extra-Small Modular aTSA Reamer is provided to aid the surgeon in the initial preparation. Connect the appropriately sized reamer to the **Cannulated Glenoid Reamer Driver (315-50-12)**. Sequentially ream the glenoid over the K-wire to the appropriate size.

Note: Avoid applying a bending force to the 3.2mm K-wire as this may cause a fracture.

Note: Check that the reamer or drill is engaged on the driver handle before starting.

Note: Start the reamer prior to engaging bone.

Note: Off-axis reaming removes less bone than would occur ordinarily during eccentric reaming to correct the same defect (i.e., reaming down the high side). For example, compare the bone removed between off-axis reaming and eccentric reaming of a defect (Figure 16).

OPTION TWO: 8-Degree Glenoid – Posterior Augment

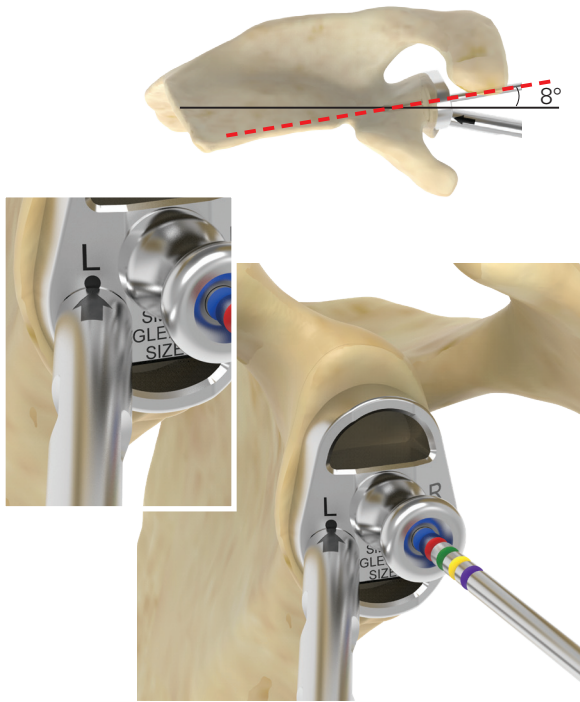

Figure 17
Drill 3.2mm Pilot Hole

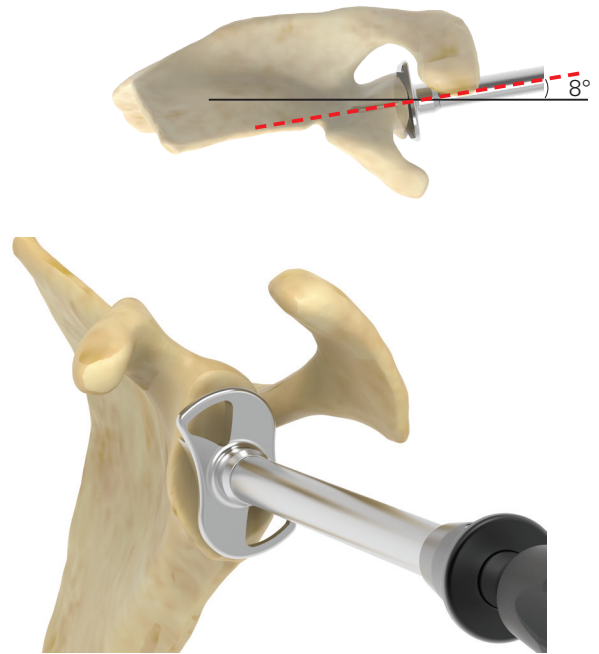

Figure 18
Ream the Glenoid

PILOT TIP - 8-DEGREE OFF-AXIS REAMING

Choose the appropriate **Glenoid Sizer (Small 315-56-02, Medium 315-56-03, Large 315-56-04, Extra Large 315-56-05)** and attach this to the Modular Glenoid Guide Handle by matching the laser marking on both the Glenoid Sizer and handle (*Figure 17*).

Note: Verify that the handle mechanism is locked on the sizer prior to inserting into the wound.

If using the Pilot Tip procedure, snap the **K-Wire Adapter (315-51-10)** into the Glenoid Sizer, then insert and start drilling a 3.2mm hole using the **3.2mm Drill W/AO (321-52-07)** drill bit. It is suggested that the surgeon drill to at least the blue (30mm) depth marking when making the pilot tip hole.

Reaming The Glenoid

Off-axis ream the glenoid using the appropriately sized reamer and the pilot tip driver. Ream the glenoid at an angle off-axis from the central axis of the scapula to match the angle of the augmented implant (*Figure 18*).

An Extra-Small Modular aTSA Reamer is provided to aid the surgeon in the initial preparation. Connect the appropriately sized Reamer to the Pilot Tip Glenoid Reamer Driver. Sequentially ream the glenoid to the appropriate size.

Note: Check that the reamer or drill is engaged on the driver handle before starting.

Note: Start the reamer prior to engaging bone.

DETAILED OPERATIVE TECHNIQUE

CANNULATED - 8-DEGREE DRILLING CENTRAL CAGE HOLE

OPTION TWO: 8-Degree Glenoid – Posterior Augment

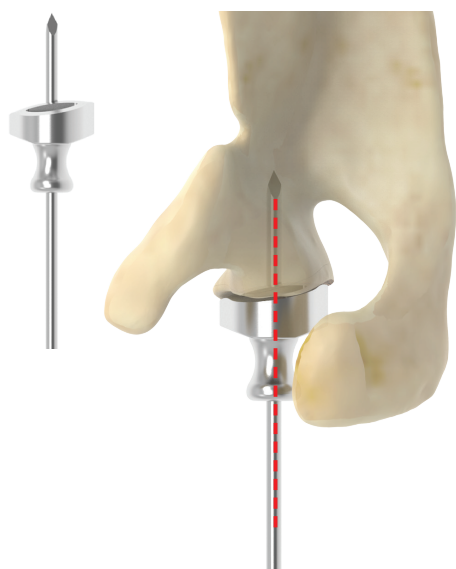

Figure 19
Augmented Drill Guide

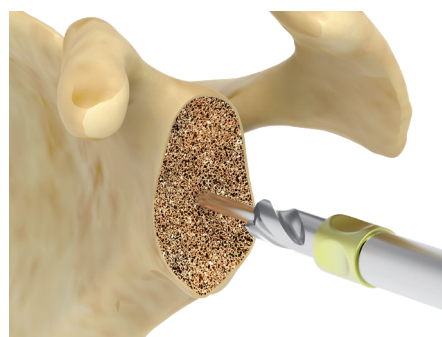

Figure 20
Drill Center Hole Over 3.2mm Steinmann Pin

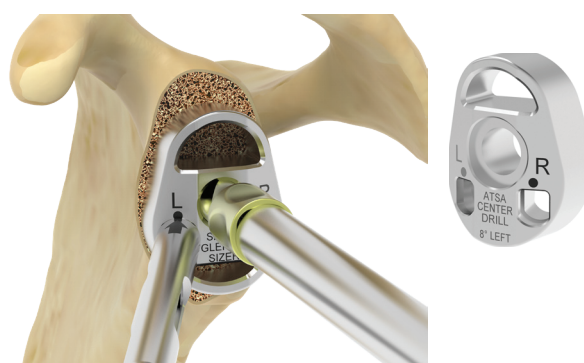

Figure 21
Pilot Tip Drill the Center Hole 8-Degree Guide

CANNULATED - 8-DEGREE DRILLING CENTRAL CAGE HOLE

Once reaming is complete, remove the off-axis 3.2mm K-wire.

Cannulated Drilling With K-Wire

Connect the **8° Center Peg Drill Guide (315-27-42/43 Left/ Right)** to the **K-Wire Adapter (315-51-10)** and **Modular Glenoid Guide Handle (315-52-11)**. Once connected, drive the **3.2mm Trocar Tip K-wire (321-52-09)** through the K-wire adapter and remove the glenoid guide (*Figure 19*).

If using the cannulated method, connect the **Modular Cannulated Center Peg Drill (315-52-65)** to the **Cannulated Glenoid Reamer Driver (315-50-12)** and drill the center hole over the **3.2mm Trocar Tip K-wire (321-52-09)**. Drill until the collar of the drill bit contacts the glenoid surface.

Do not drill through the Modular Center Peg Guide if using the Cannulated Technique (*Figure 20*).

WARNING: Avoid applying a bending force to the 3.2mm Steinmann Pin as this may cause a fracture. Driver and drill bits should be removed by pulling straight back over the wire to prevent unnecessary bending.

Pilot Tip Drilling With Drill Guide

If using the Pilot Tip method, connect the Modular Center Peg Drill to the **Cannulated Glenoid Reamer Driver (315-50-12)** and drill the center hole through the appropriate angle and side Center Peg Drill Guide (8-degree: 315-27-42 (Left) and 315-27-43 (Right) (*Figure 21*).

Note: Ensure that the central cage hole is drilled on-axis relative to the prepared glenoid. Off-axis drilling can lead to misaligned peg holes and prestress the poly/peg interfaces.

OPTION TWO: 8-Degree Glenoid – Posterior Augment

Size	8° Peg Glenoid Trial Color
S	Blue
M	Green
L	Purple
XL	Yellow

Table 3
Glenoid Size Color Coded Trials

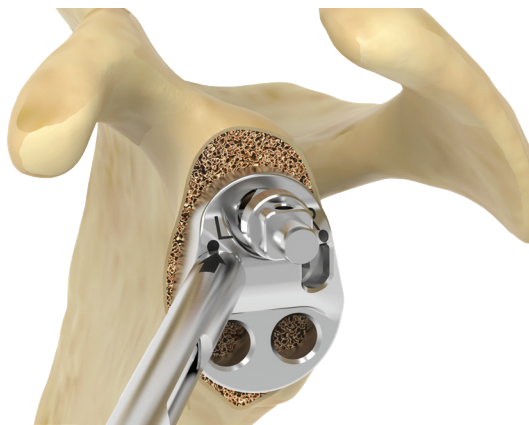

Figure 22
Drill the Peripheral Holes

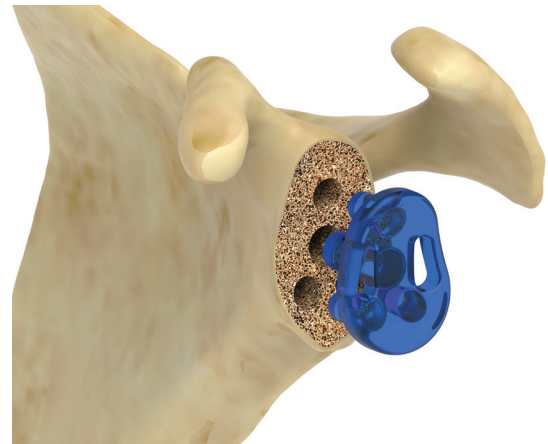

Figure 23
Insert 8° Peg Glenoid Trial

Drilling For Augmented Peripheral Pegs

Connect the Modular Glenoid Guide Handle to the appropriate **Peripheral Peg Drill Guide (8-degree: 315-27-44 Left and 315-27-45 - Right)**.

Connect the **Modular Peripheral Peg Drill (315-52-62)** to the **Peripheral Peg Driver (315-52-01)** and drill the three peripheral holes through the Peripheral Peg Drill Guide (*Figure 22*).

Note: Avoid levering on the Peripheral Peg Drill guide after drilling.

When drilling the peripheral peg holes, the Modular Peripheral Peg Drill will release and act as the holding pin for the Peripheral Hole Drill Guide, as needed.

Note: Ensure that the peripheral peg holes are drilled on-axis relative to the central cage hole. Off-axis drilling can lead to misaligned peg holes and prestress the poly/peg interfaces.

Glenoid Trialing

After drilling the peripheral holes, and removing the Drills and Drill Guide, use the appropriate **8° Peg Glenoid Trial (8-degree: 315-63-XX)** to ensure correct coverage as well as to check that the holes were prepared to the defined depth (*Figure 23*). If the Pegged Glenoid Trial is not fully seated, redrill holes as needed.

Note: Pegged Glenoid Trials were designed to fit conveniently in Allis clamps or forceps for easy insertion/removal.

Since the peg pattern/spacing is the same on all sizes, the surgeon may easily upsize or downsize the Cage Glenoid to achieve the best coverage (provided that all the cortical bone was reamed).

Note: Trials are color-coded (*Table 3*).

DETAILED OPERATIVE TECHNIQUE

CEMENTING THE CAGE GLENOID/FINAL AUGMENTED GLENOID IMPLANTATION

OPTION TWO: 8-Degree Glenoid – Posterior Augment

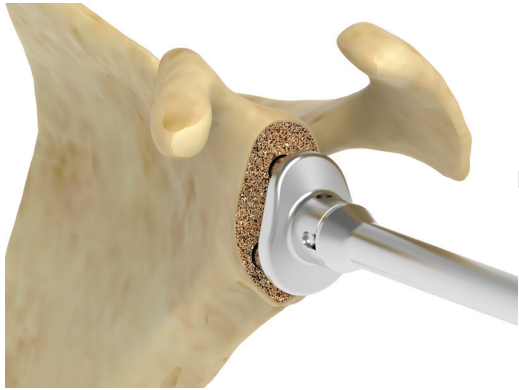

Figure 24
Pressurize the
Cement

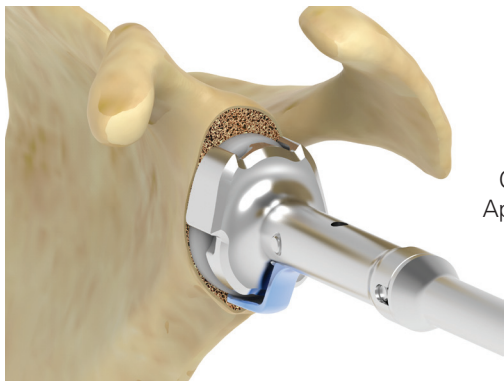
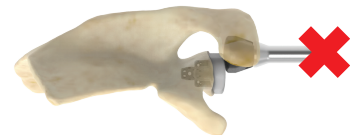

Figure 25
Impact Cage Glenoid
Component Using the
Appropriately Sized aTSA
Glenoid Impactor



Off-Center Impactation



Off-Axis Impactation



Off-Axis & Off-Center Impactation



On-Axis Impactation

Cementing The Cage Glenoid

Prepare the glenoid by first copiously irrigating the holes to clear any debris. Cement should be placed in each of the peripheral drilled peg holes. After placing cement, the Cement Pressurizer Peripheral Pegs (315-57-08) should be used to pressurize the cement in the glenoid (Figure 24). A second injection of cement with thumb pressurization is then completed.

Note: When inserting the final implant, keep the inserter pointed up with a hand underneath until the implant is in the wound.

FINAL AUGMENTED GLENOID IMPLANTATION

The glenoid component is then seated using the correct size aTSA Glenoid Impactor (Small 315-55-02, Medium 315-55-03, Large 315-55-04, X-Large (315-55-04) (Figure 25). Each Impactor is color-coded to match their corresponding glenoid trials. Ensure the aTSA Glenoid Impactor is fully assembled to the Impactor Handle before striking.

Note: Confirm that the correct side augment is being inserted by locating the L or R on the backside of the implant.

Note: Ensure straight line visibility for cage insertion.

Note: Only impact the glenoid component in the center of the articular surface on-axis with the central cage, ensuring the impactor tip remains assembled throughout the insertion process. Do not impact off-axis and/or off-center as shown in Figure 25 above as this can lead to damage to the poly/peg interfaces.

Strike the Glenoid Impactor with a mallet to ensure that the glenoid component is in complete contact with the bone. Apply firm, steady digital pressure on the glenoid until polymerization is complete. Run a small elevator around the edge of the glenoid component to ensure there is no interposed soft tissue. Excess cement around the edges of the glenoid implant is removed before the cement polymerizes.

OPTION TWO: 8-Degree Glenoid – Posterior Augment



Figure 26
Trepine Drill Guide &
Modular Guide Handle



Figure 28
Cannulated Driver and
Trepine Drill



Figure 27
Trepine Drill Guide and Peripheral Peg
Trepine Guide Insert

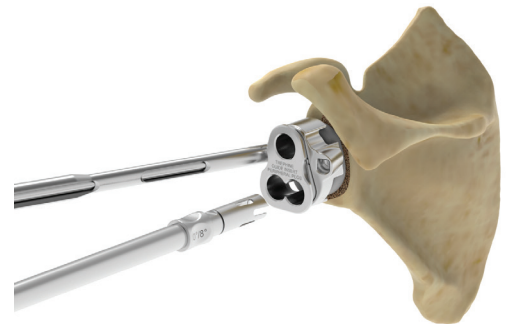

Figure 29
Insertion of Trepine Through Guide/Insert

REMOVING THE CAGE GLENOID

Should the implant need to be removed after implantation for any reason, instrumentation is available to facilitate revision.

FULL CAGE/PEG DEPTH DRILLING

The appropriately sized **Trepine Drill Guide (315-58-02/03/04/05)** is connected to the Modular Glenoid Guide Handle by matching the laser marking on both the Glenoid Guide and Handle (*Figure 26*).

The **Peripheral Peg Trepine Guide Insert (315-58-11)** (*Figure 27*) is snapped into the Guide. The Guide is then placed onto the face of the glenoid implant with care taken that it is fully seated on the articular surface.

With the Guide in position, the **Peripheral Peg Trepine Drill 0/8 Degree (315-58-13)** is connected to the Cannulated Glenoid Reamer Driver (315-50-12) (*Figure 28*) and inserted into one of the Guide holes (*Figure 29*).

Drilling is commenced at a slow to moderate speed, ensuring that the Trepine is drilled on-axis.

DETAILED OPERATIVE TECHNIQUE

REMOVING THE CAGE GLENOID

OPTION TWO: 8-Degree Glenoid – Posterior Augment

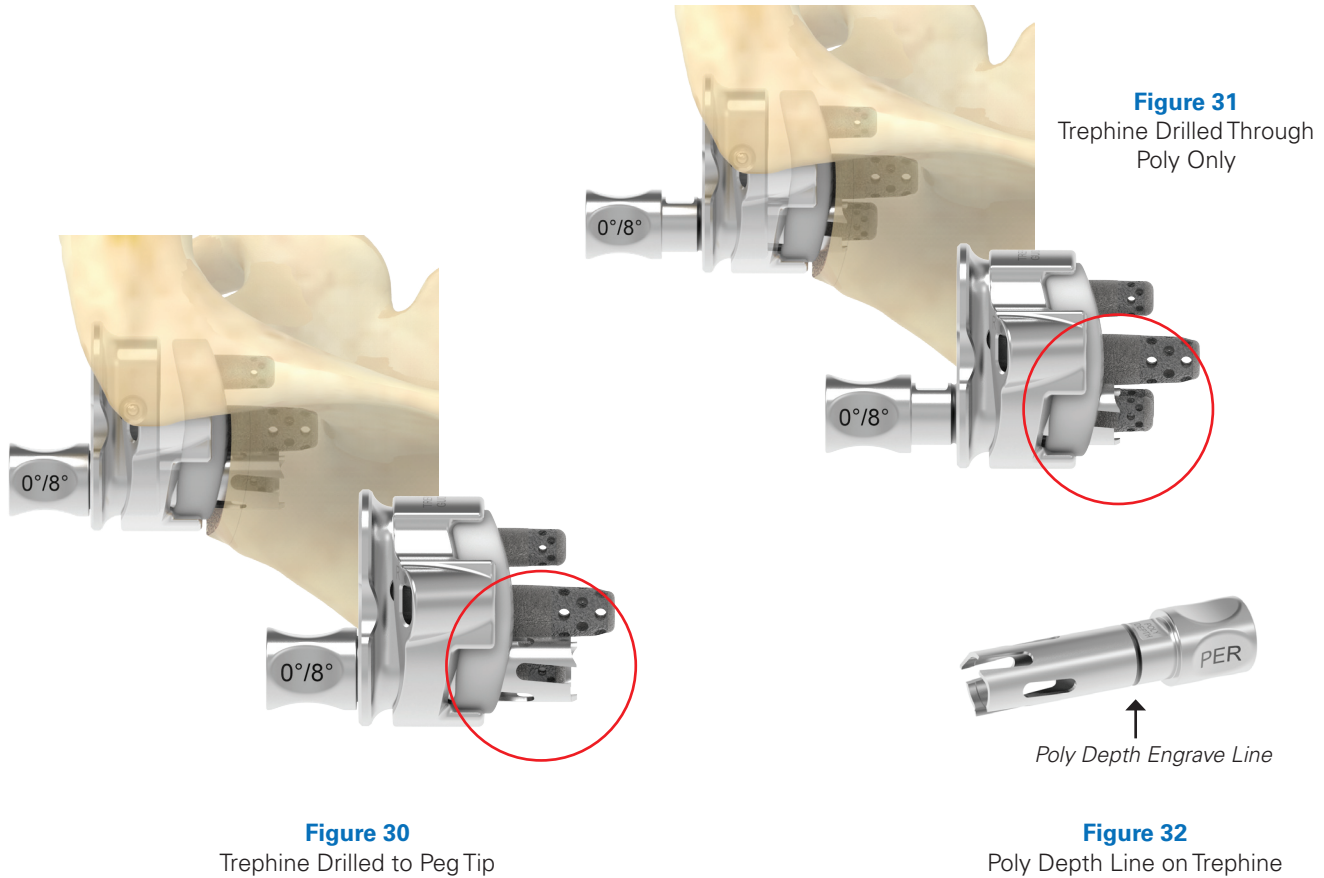

Once the Trephine has bottomed out on the guide (*Figure 30*), remove it from the guide along with the contained polyethylene/peripheral peg; after removing the peg from the trephine, repeat these steps to remove all three peripheral pegs.

Note: The Trephine Drills have a close fit with the holes of the Guide Inserts. To avoid separating the Guide Insert from the Guide, ensure the Trephine Drill is removed directly on-axis to the Guide Insert hole. Additionally, digital pressure may be applied to the face of the Guide Insert during Trephine Drill removal.

After removal of the Peripheral Peg Trephine Guide Insert from the Trephine Drill Guide, the **Central Cage Trephine Guide Insert (315-58-10)** is snapped into the Trephine Guide and the guide is placed back onto the face of the implant.

With the guide in position, the **Trephine Drill 0/8 Center Cage (315-58-12)** is inserted, and drilling is commenced at a slow/moderate speed (*Figure 30*). Once the drill has bottomed out, remove the trephine and guide, along with the center cage and remaining polyethylene body.

Note: The Trephine Drills should not be used to drill through the glenoid implant without the use of the Trephine Guide and Guide Insert.

POLY DEPTH DRILLING

As an alternative technique, the trephines can be used to drill through only the polyethylene body (*Figure 31*) by drilling down to the engrave line that is marked as "Poly Depth" (*Figure 32*) on both the peripheral peg and central cage drilling steps. The bulk of the poly can then be removed, leaving four poly cylinders exposed; these cylinders can then be grabbed with surgical pliers or a rongeur to twist each peg out individually.

CATALOG NUMBER PART DESCRIPTION

Laser Cage 0-Degree Glenoid

314-23-02	Laser Cage Glenoid Small, Alpha
314-23-03	Laser Cage Glenoid Medium, Alpha
314-23-04	Laser Cage Glenoid Large, Alpha
314-23-13	Laser Cage Glenoid Medium, Beta
314-23-14	Laser Cage Glenoid Large, Beta
314-23-15	Laser Cage Glenoid Extra-Large, Beta



Laser Cage 8-Degree Glenoid

314-24-22	Laser Cage Glenoid S, 8 Post Aug, Left
314-24-23	Laser Cage Glenoid M, 8 Post Aug, Left
314-24-24	Laser Cage Glenoid L, 8 Post Aug, Left
314-24-25	Laser Cage Glenoid XI, 8 Post Aug, Left
314-24-32	Laser Cage Glenoid S, 8 Post Aug, Right
314-24-33	Laser Cage Glenoid M, 8 Post Aug, Right
314-24-34	Laser Cage Glenoid L, 8 Post Aug, Right
314-24-35	Laser Cage Glenoid XI, 8 Post Aug, Right

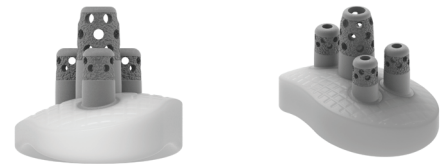

INSTRUMENT LISTING

8-Degree Augment

315-27-42	8° Center Peg Drill Guide, L
315-27-43	8° Center Peg Drill Guide, R
315-27-44	8° Peripheral Peg Guide, L
315-27-45	8° Peripheral Peg Guide, R



315-50-00	aTSA Reamer, Starter
315-50-01	aTSA Reamer, Small
315-50-02	aTSA Reamer, Medium
315-50-03	aTSA Reamer, Large
315-50-04	aTSA Reamer, X-Large



315-63-22	8° Peg Glenoid Trial, Small, Left
315-63-23	8° Peg Glenoid Trial, Medium, Left
315-63-24	8° Peg Glenoid Trial, Large, Left
315-63-25	8° Peg Glenoid Trial, X-Large, Left
315-63-32	8° Peg Glenoid Trial, Small, Right
315-63-33	8° Peg Glenoid Trial, Medium, Right
315-63-34	8° Peg Glenoid Trial, Large, Right
315-63-35	8° Peg Glenoid Trial, X-Large, Right

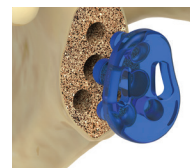

Note: 0-degree trials listed in the Equinox Ergo aTSA hum/glen instrument tray (KIT-311T).

REVISION & DISPOSABLE INSTRUMENTS LISTING

CATALOG NUMBER

PART DESCRIPTION

315-58-02 Trepine Drill Guide, Small
 315-58-03 Trepine Drill Guide, Medium
 315-58-04 Trepine Drill Guide, Large
 315-58-05 Trepine Drill Guide, X-Large



315-58-10 Trepine Guide Insert–Central Cage



315-58-11 Trepine Guide Insert–Peripheral Pegs



315-58-12 Trepine Drill–0 / 8 Deg, Center Cage
 315-58-13 Trepine Drill–0 / 8 Deg, Peripheral



DISPOSABLE INSTRUMENTS

321-52-07 3.2mm Drill W/AO
 321-52-09 3.2mm Trocar Tip K-wire
 321-52-10 3.2mm Short Threaded K-Wire - 2PK



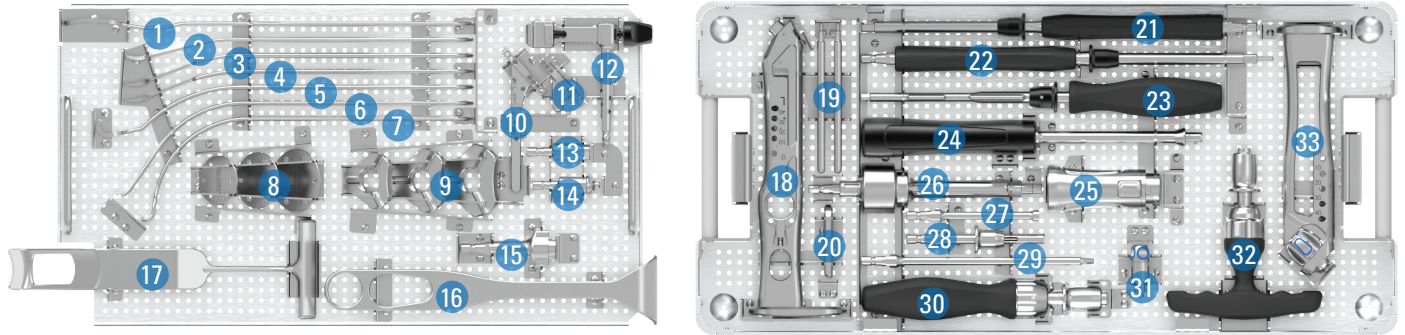

EQUINOXE ERGO CORE INSTRUMENT TRAY (KIT-311X)

1	Darrach Retractor	317-11-03
2	Small Forked Retractor	317-21-01
3	Hohmann Retractor	317-11-06
4	Hohmann Retractor	317-11-06
5	Wolfe Retractor	317-11-08
6	Dual Point Glenoid Retractor	317-11-04
7	Humeral Head Retractor	317-11-02
8	Small Humeral Protector	301-08-21
8	Medium Humeral Protector	301-08-41
8	Large Humeral Protector	301-08-61
9	Calcar Planer Blade 44mm	301-09-44
9	Calcar Planer Blade 50mm	301-09-50
9	Calcar Planer Blade 56mm	301-09-56
10	132.5 Degree Osteotomy Guide	311-11-13
11	IM Resection Guide	311-11-14
12	IM Guide Boom	311-11-11
13	Calcar Planer Adapter - Female Broach	301-09-01
14	Calcar Planer Adapter - Stem	301-09-02
15	Calcar Planer Body	301-09-00
16	Deltoid Retractor	317-21-06
17	Klimo Fukuda Retractor	317-21-05
18	EQII Broach Handle	301-05-02
19	Version Rod	301-05-20
20	Broach Collar	301-05-03
21	Cannulated Glenoid Reamer Driver	315-50-12
22	Pilot Tip Glenoid Reamer Driver	315-50-11
23	Modular Glenoid Guide Handle	315-52-11
24	Modular Impactor Handle	321-09-05*
25	Modular Counter Torque Handle	301-16-36
26	Geared Torque Screw Driver	321-16-69
27	Torque Defining Screw Removal Instrument	301-16-10
28	Glenoid Plate Coring Reamer	321-09-10
29	Hex Screw Driver 3.5mm	321-19-08
30	Non-Ratcheting Handle	301-09-90
31	Stem Extraction Tool	301-09-12
32	Ratcheting T-Handle	301-09-30
33	EQII Stem Inserter	301-09-20

*The Impactor Handle (321-07-05) can be used as a substitute as needed.

INSTRUMENT LISTING

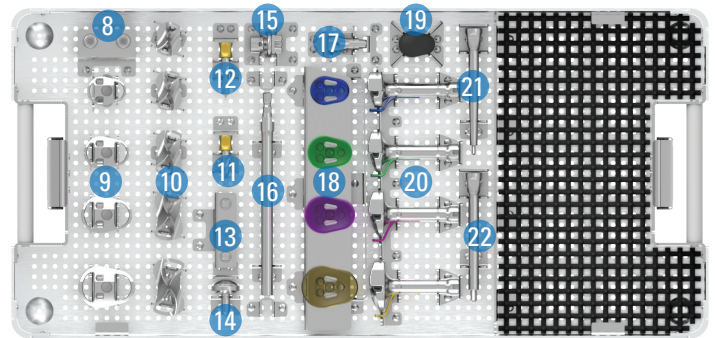
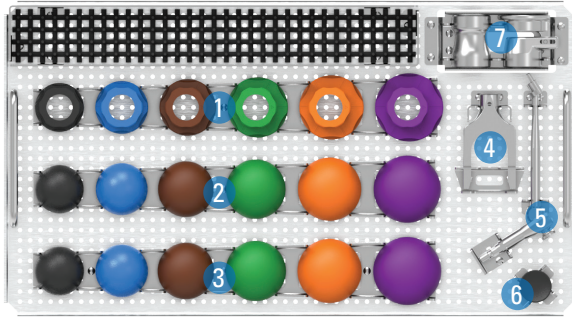

EQUINOXE ERGO aTSA HUM/GLEN INSTRUMENT TRAY (KIT-311T)

1	Plate Dial 38mm	301-13-38
1	Plate Dial 41mm	301-13-41
1	Plate Dial 44mm	301-13-44
1	Plate Dial 47mm	301-13-47
1	Plate Dial 50mm	301-13-50
1	Plate Dial 53mm	301-13-53
2	Short Head Trial 38mm	311-11-38
2	Short Head Trial 41mm	311-11-41
2	Short Head Trial 44mm	311-11-44
2	Short Head Trial 47mm	311-11-47
2	Short Head Trial 50mm	311-11-50
2	Short Head Trial 53mm	311-11-53
3	Tall Head Trial 38mm	311-12-38
3	Tall Head Trial 41mm	311-12-41
3	Tall Head Trial 44mm	311-12-44
3	Tall Head Trial 47mm	311-12-47
3	Tall Head Trial 50mm	311-12-50
3	Tall Head Trial 53mm	311-12-53
4	Head Removal Tool	311-09-01
5	Replicator Alignment Handle	301-16-41
6	Humeral Head Impactor Tip	311-09-07
7	Anatomic Counter Torque 1.5/4.5 Offset Tip	301-16-37
7	Anatomic Counter Torque 0 Offset Tip	301-16-38
8	K-wire adapter (2 Kits)	315-51-10
9	Glenoid Sizer Small	315-56-02
9	Glenoid Sizer Medium	315-56-03
9	Glenoid Sizer Large	315-56-04
9	Glenoid Sizer Extra Large	315-56-05
10	Modular aTSA Reamer Extra Small	315-50-01
10	Modular aTSA Reamer Small	315-50-02
10	Modular aTSA Reamer Medium	315-50-03
10	Modular aTSA Reamer Large	315-50-04
10	Modular aTSA Reamer Extra Large	315-50-05
11	Modular Cannulated Central Peg Drill	315-52-65
12	Modular Central Peg Drill	315-52-64
13	Modular Peripheral Peg Drill (3)	315-52-62
14	Peripheral Peg Drill Guide	315-57-04
15	Cement Pressurizer Peripheral Pegs	315-57-08
16	Peripheral Peg Driver	315-52-01
17	Cement Pressurizer Central Peg	315-57-07
18	Pegged Glenoid Trial Small	315-53-02
18	Pegged Glenoid Trial Medium	315-53-03
18	Pegged Glenoid Trial Large	315-53-04
18	Pegged Glenoid Trial Extra Large	315-53-05
19	Glenoid Impactor Tip	315-57-06
20	aTSA Glenoid Impactor Small	315-55-02
20	aTSA Glenoid Impactor Medium	315-55-03
20	aTSA Glenoid Impactor Large	315-55-04
20	aTSA Glenoid Impactor Extra Large	315-55-05
21	Peripheral Peg Extractor	315-57-18
22	Central Peg Extractor	315-57-17

SYSTEM SPECIFICATIONS

(ALL DIMENSIONS IN MILLIMETERS)

GLENOIDS

Sizes	Fixation	Material	Radial Mismatch	Shape
Small	Cage, Peg	Compression Molded UHMWPE	Mean: 5.5	Anatomic (Pear)
Medium				
Large				
Extra Large	Cage, Peg			



HUMERAL STEM

Distal Diameter	Length*	Inherent Medial Offset	Material	Surface Finish		Geometry	
				Proximal	Distal	Proximal	Distal
7	100	7.5	Ti-6Al-4V	16 grade grit blast	Hi-Brite Polish	Trapezoidal	Cylindrical with Flutes
8	102.5						
9	105						
10	107.5						
11	110	8.5					
12	112.5	9.5					
13	115						
14	117.5						
15	120						
17	125						
19	127.5						

*Measured from distal tip to center of proximal spherical bore

LONG STEM

Distal Diameter	Length	Inherent Medial Offset
8	175	7.8
8	215	
10*	200	
11*	200	

*Special order

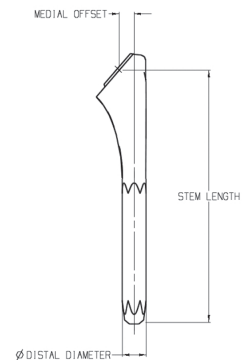

REPLICATOR PLATES

Offset	Material	Offset Ranges*		Angle Ranges (°)	
		Med/Lat	Ant/Post	Inclination	Version
1.5	Ti-6Al-4V	0-14	0-6	125-140	+/-7.5
4.5					

*Includes effect of head offsets

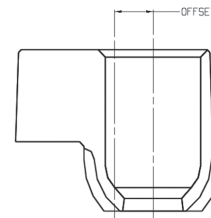

REFERENCES

1. 718-01-30, Equinox Platform Shoulder System Operative Technique
2. 00-0000121, Equinox Platform Shoulder System with Ergo® Instruments Operative Technique

For additional device information, refer to the Exactech Preserve Stem Instructions for Use for a device description, indications, contraindications, precautions and warnings. For further product information, please contact Customer Service, Exactech, Inc., 2320 NW 66th Court, Gainesville, Florida 32653-1630, USA. (352) 377-1140, (800) 392-2832 or FAX (352) 378-2617.

Exactech, as the manufacturer of this device, does not practice medicine, and is not responsible for recommending the appropriate surgical technique for use on a particular patient. These guidelines are intended to be solely informational and each surgeon must evaluate the appropriateness of these guidelines based on his or her personal medical training and experience. Prior to use of this system, the surgeon should refer to the product package insert for comprehensive warnings, precautions, indications for use, contraindications and adverse effects.

The products discussed herein may be available under different trademarks in different countries. All copyrights, and pending and registered trademarks, are property of Exactech, Inc. This material is intended for the sole use and benefit of the Exactech sales force and physicians. It should not be redistributed, duplicated or disclosed without the express written consent of Exactech, Inc. ©2023 Exactech, Inc. 00-0002668 Rev. B 0423

Exactech is proud to have offices and distributors around the globe.
For more information about Exactech products available in your country, please visit www.exac.com



EXACTECH, INC.
2320 NW 66TH COURT
GAINESVILLE, FL 32653 USA

+1 352.377.1140
+1 800.EXACTECH
+1 352.378.2617 (FAX)
www.exac.com