

EXACTECH | SHOULDER

Operative Technique



GPS | SHOULDER

GPS® Shoulder Application 2.1
Using Equinoxe® Ergo® Instruments



TABLE OF CONTENTS

SYSTEM OVERVIEW	1
GPS® SHOULDER APPLICATION WORKFLOW OVERVIEW	2
DETAILED STEPS PRIOR TO GPS	3
Patient and Station Positioning	3
Case and Plan Selection	4
Preparation	5
Surgical Steps	7
DETAILED OPERATIVE TECHNIQUE	22
Primary Shoulder	22
Reverse Shoulder	33
INSTRUMENT LISTING	42
SOFTWARE REQUIREMENTS	44

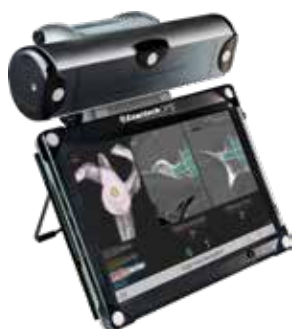

The GPS Shoulder Application was developed in conjunction with:

Ian Byram, MD

Bone and Joint Institute
of Tennessee
Nashville, TN

Emilie V. Cheung, MD

Stanford University
Palo Alto, CA

Pierre Henri Flurin, MD

Bordeaux-Merignac Clinic
Bordeaux, France

Richard B. Jones, MD

Southeastern Sports Medicine
Asheville, NC

Rick Papandrea, MD

Orthopaedic Associates
of Wisconsin
Milwaukee, WI

Moby Parsons, MD

The Knee Hip and
Shoulder Center
Portsmouth, NH

Paul Saadi, MD

Dallas Bone and Joint
Dallas, TX

Thomas Wright, MD

University of Florida
Gainesville, FL

Ari Youderian, MD











SCOS Orthopedic Specialists
Orange County, CA

Joseph Zuckerman, MD

NYU Langone
Orthopedic Hospital
New York, NY



Screen Layout

Icon		Description
	Switch OFF	Switch OFF the station.
	AUGI App	Connect to AUGI App.
	Tools	Access maintenance options.
	Change Language	Change the default language of the software.
	Total Shoulder	Access detailed options related to total shoulder application.
	Screenshot	Take a screen shot of the current screen. The picture is recorded in the operative report.
	Go Forward	Go to the next step.
	Go Backward	Go to the previous step.
	Menu	Access to options (exit, reconnect trackers...)
	Exit	Exit the shoulder application.

GPS SHOULDER APPLICATION WORKFLOW OVERVIEW

Workflow: Preoperative Planning and GPS Surgery

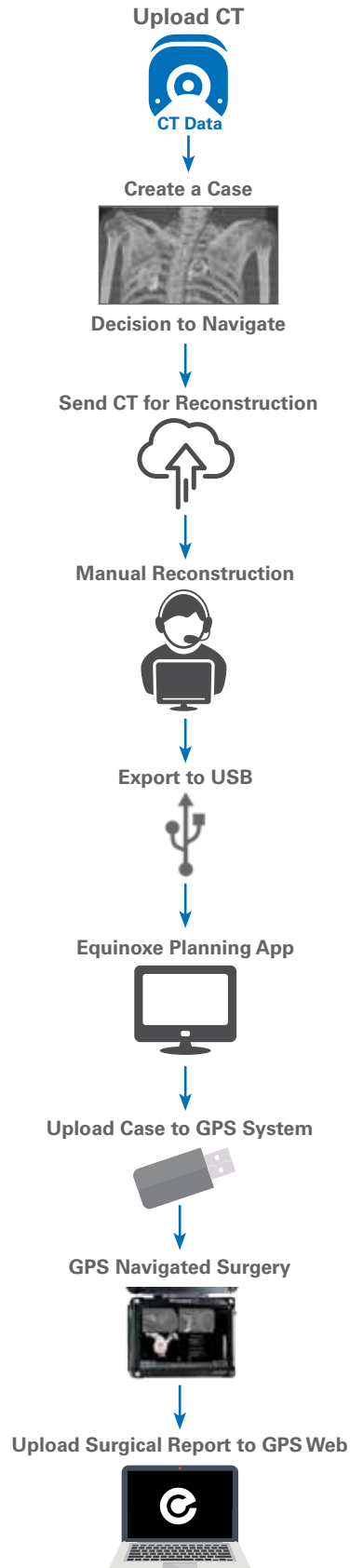

DETAILED STEPS PRIOR TO GPS

PATIENT AND STATION POSITIONING

Patient Positioning

The patient should be placed on an operating table in a supine position. The head of the operating table should be elevated approximately 30° in a modified beach chair position. A small bolster should be placed laterally behind the involved shoulder. The patient should be moved to the side of the table so that the upper extremity can be placed into maximum extension without obstruction by the operating table. Alternatively, a Captain's chair or similar positioning device can be used for proper patient positioning. The patient should be secured to the operating table to minimize any changes in position intraoperatively.

Once the patient is secure, the extremity is examined to assess the range of motion, with particular attention to external rotation with the arm at the side. If external rotation is restricted (i.e. internal rotation contracture) the need for more extensive subscapularis mobilization or lengthening procedures may be necessary. The entire upper extremity should be prepped to allow complete access to the operative area and full mobility during the procedure.

Station Positioning

With the patient in place, the GPS station may be set up. The station should be placed near the patient's opposite hip where visibility is optimal. Attach the GPS clamp to the bed rail under the patient's hips on the contralateral side, assuming there is one rail under the back, one rail under the hips, and one rail under the lower legs. Bring the clamp all the way up to the edge of the bed rail under the hips, toward the patient's head.

If patient positioning is too flat or supine, Tracker visibility with the station could be impeded. If the surgeon prefers not to adjust the patient position to a beach chair angle, the station should be adjusted on the table closer and superior to the hip. The arm holder/pad for the non-operative arm should be positioned toward the head (elbow pulled back) so the station can sit higher on the rail for better line of sight to the tracker.

Drape the patient once the station is in the optimal position (GPS station and arm are attached to bed rail). Connect all cables and the USB key before draping. Once the GPS station is draped, connectors are not accessible. Take the sterile drape by the two tabs and place it on the GPS Station from the top, with the transparent sheet on the screen side. Unroll the drape all along the mounting arm (if using the cart, unroll along the cart). Position the transparent sheet in front of the screen; exact positioning will then be done automatically. Remove the open windows protection and throw it away immediately.

Alternatively, the surgeon may choose to use the mobile cart, which provides flexibility for height adjustments and mobility between cases. The cart's offset arm allows the GPS station to remain in the sterile field. Draping application and removal can be performed quickly.



Figure 1

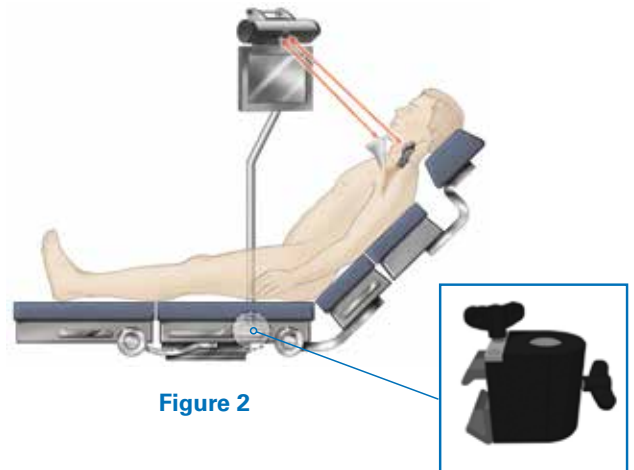

Figure 2

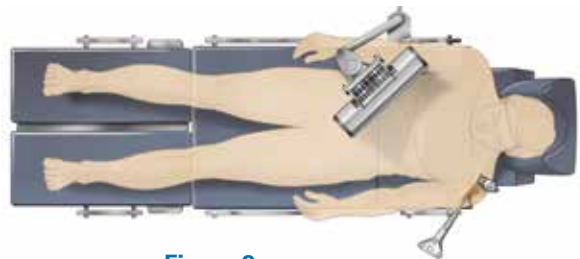

Figure 3

Note: When draping, it is helpful to adjust the head holder all the way back, and turn the patient's head to the contralateral side if possible. This helps to keep the drapes and intubation away from obstructing the view of the trackers. It can also be helpful to tape down the drapes around the patient's head.

Ensure the camera and station have line-of-sight to the incision to guarantee visibility throughout the technique (Figures 1-3).

Note: In a cold room or climate, start the station 30-45 min. in advance to ensure proper Tracker/camera visibility. When plugging in the station, first screw the power cable into the back of the station, then plug the other end of the power cable into the wall, and finally turn on the unit.

DETAILED STEPS PRIOR TO GPS

CASE AND PLAN SELECTION

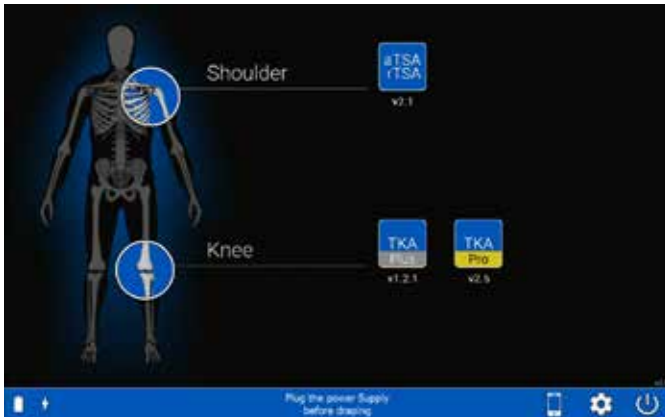

Figure 4

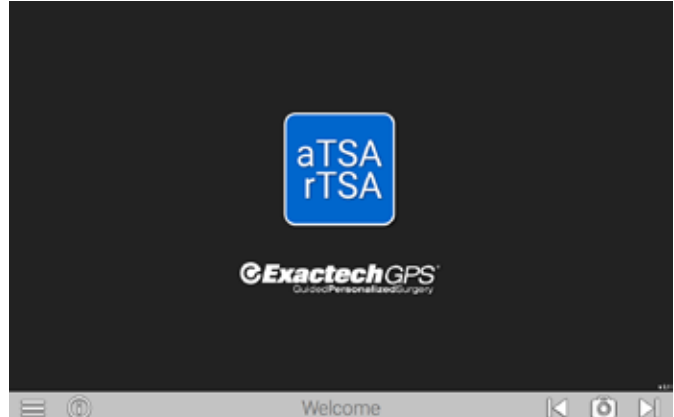

Figure 5



Figure 6



Figure 7

CASE AND PLAN SELECTION

Press the Shoulder Application icon on the GPS unit. On the Case and Plan Selection screen (Figure 6), select Import Case to import a case from a USB. If the case is already on the unit, click the box with the drop down and be sure to select the correct Patient ID. Depending on what plans were exported, select the Anatomic or Reverse plans to navigate with GPS. Ensure the patient information displayed matches the patient in the OR.

Note: A plan can still be edited or created based on what was imported by pressing the Edit or Create button under the Anatomic or Reverse sections.

INSTRUMENTATION SELECTION

Next, on the instrumentation selection screen, verify the instrument set being used. If using Equinoxe Legacy GPS instruments, select the “change to Legacy button” at the top right of the screen and follow the 2.1 Equinoxe Legacy operative technique (Figures 6 and 7).

Next, select the option for either Pilot Tip or Cannulated instrumentation. Surgeons may also select/unselect whether they will be using the rotation and implant impaction/insertion instruments and features.

Verify that the correct orientation of the station setup by reviewing the Station Setup screen after advancing.



Figure 8

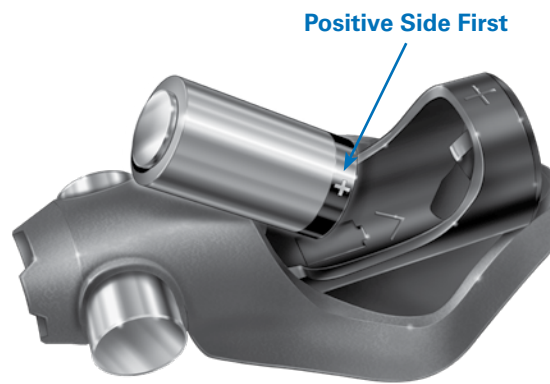

Figure 9

BATTERY INSERTION

The Seeking Tracker screen is displayed (Figure 8). Insert batteries, positive side first, into the three Trackers **Probe Tracker (P)**, **Glenoid Tracker (G)**, and **Tool Tracker (T)** (Figure 9).

Caution: Inserting negative side first or in reverse polarity may cause permanent damage to the Tracker.

Note: Use only the dedicated sterile batteries provided in the GPS disposable kit. Do not reuse or sterilize the batteries.

When the battery is properly inserted, a LED on each Tracker will illuminate solid red/orange then begin to blink green. Position the Trackers such that the LEDs face the GPS Unit. An audible tone will indicate when each Tracker connects to the GPS system. At the same time, the respective Tracker is highlighted on the Unit, and the LED illuminates solid orange. After the camera and three Trackers connect, the system will automatically advance to the next screen.

Note: In a cold room or climate, start the station 30-45 min. in advance to ensure proper Tracker/camera visibility.

Discard all used and unused batteries after completing the procedure.

DETAILED STEPS PRIOR TO GPS

PREPARATION



Figure 10

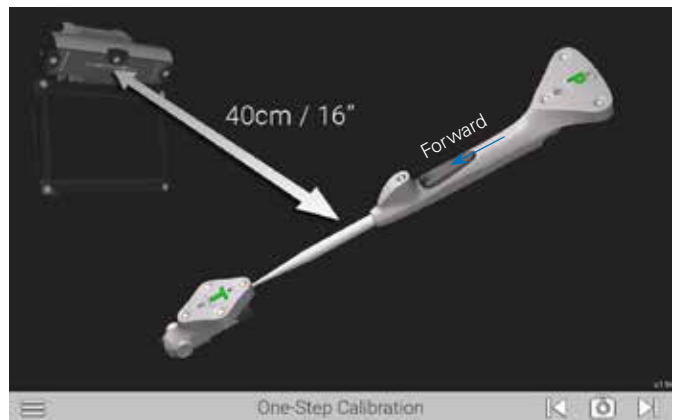

Figure 11

FINAL CONFIRMATION

Once a case has been selected, the surgeon will be shown a final confirmation screen that confirms the patient and preoperative plan. This now includes implant selection, planned version and inclination, implant location and % backside coverage (Figure 10).

ONE-STEP CALIBRATION

Follow the onscreen prompts for calibrating the Probe and Tracker. This step confirms that the probe's readings are accurate.

The One-Step Calibration screen is displayed (Figure 11). Place the tip of the Probe Tracker (P) into the dimple node at the top of the T Tracker. Hold both together **no more than** 16 inches from the display unit ensuring the white diodes are facing the camera.

When positioned correctly, the T and P status indicators on the display will appear green. Press the Forward button on the probe to initiate calibration. The progress bar will fill and an audible tone will indicate successful calibration. The system will automatically advance to the next screen.

Note: This is the only point of the operation where the surgeon will be required to hold the trackers this close to the screen.

Note: After pairing, the surgeon may attach the T Tracker to the Ergo GPS Pilot-tip Driver at this point. At any point in the procedure where a Tracker is attached to an instrument, test the physical connection every time by firmly tugging on the Tracker once it is attached. The Tracker will remain in place if it is properly attached.

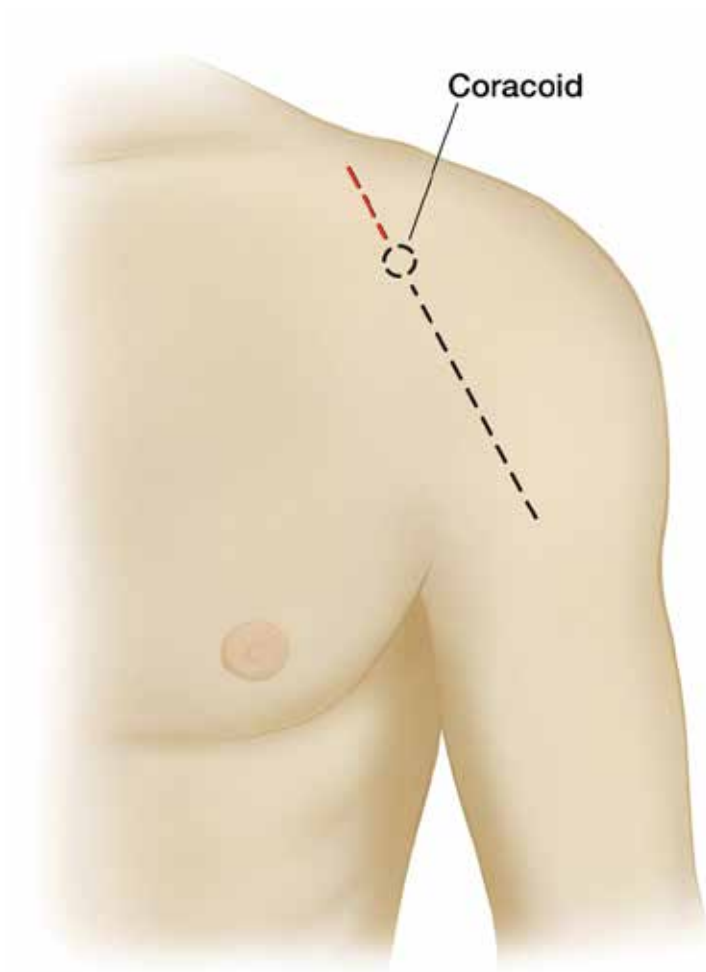

Figure 12

An anterior deltopectoral incision is made beginning inferior to the clavicle and passing over the coracoid process and extending distally toward the deltoid insertion (*Figure 12*). Medial and lateral subcutaneous flaps are created, and the deltopectoral interval is identified.

The position of the Tracker on the coracoid requires exposure of the coracoid bone. The incision should start 10mm proximal to the tip of the coracoid to guarantee exposure and minimize tissue tension throughout the case. The extended incision is required to minimize soft tissue force on the Tracker fixation throughout the case.

DETAILED STEPS PRIOR TO GPS

SURGICAL STEPS

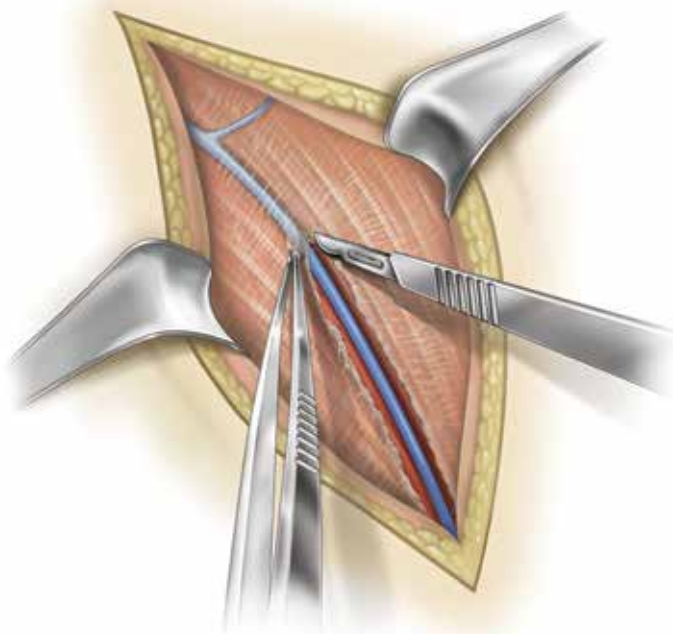

Figure 13

A thin fat stripe is usually located over the cephalic vein; the interval can be developed laterally depending on the surgeon's preference (*Figure 13*). Branches of the cephalic vein on the approach side are cauterized, and the interval is developed inferior to superior to expose the clavipectoral fascia.

The advantage of retracting the cephalic vein with the deltoid is the majority of the branches come from the deltoid. The disadvantage is the vein is more exposed to injury from the retractor as it crosses the superior aspect of the interval.

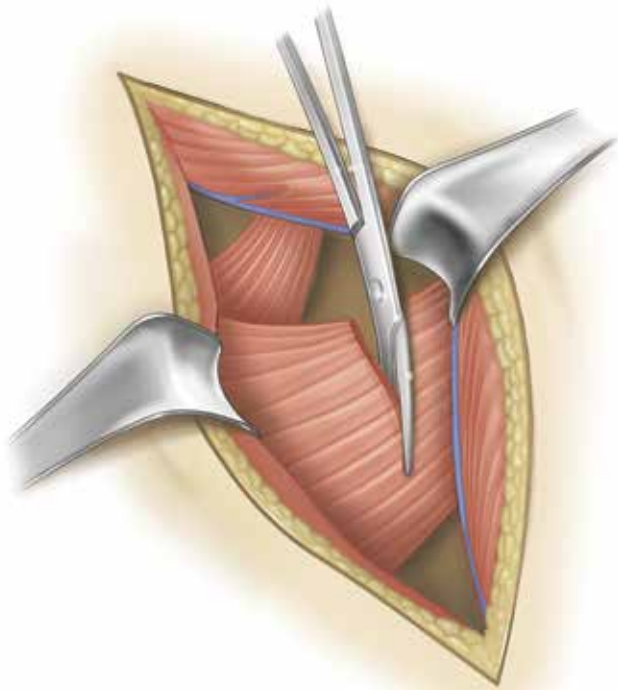

Figure 14

Resect the upper 1/3 of pectoralis tendon (*Figure 14*).

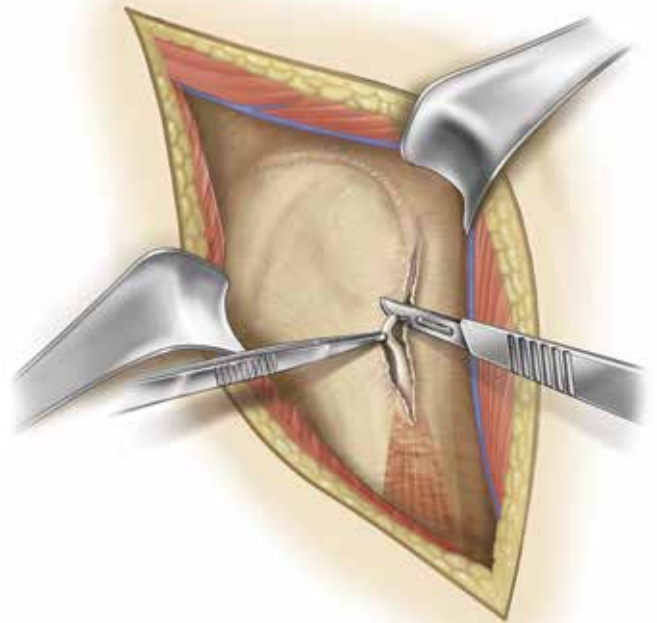

Figure 15

Tenodesis the biceps tendon (*Figure 15*).

DETAILED STEPS PRIOR TO GPS

SURGICAL STEPS

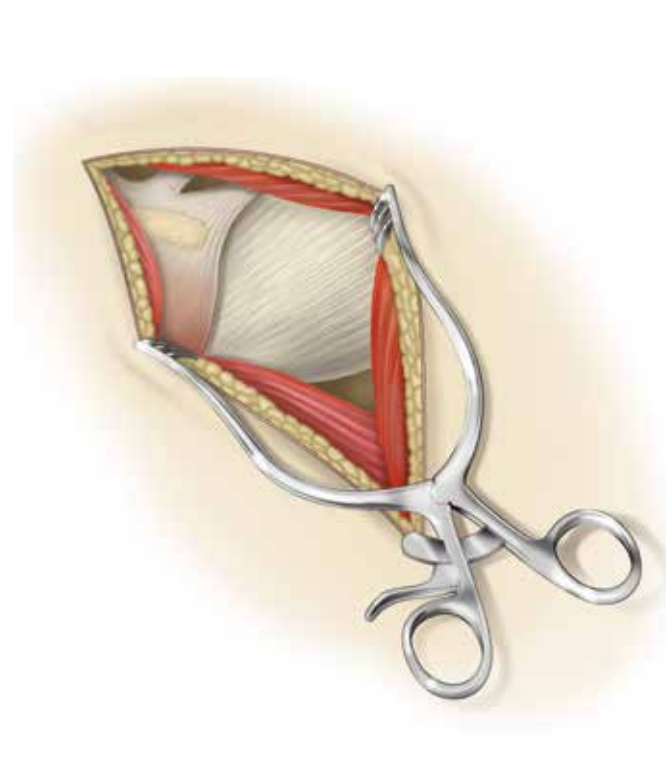

Figure 16

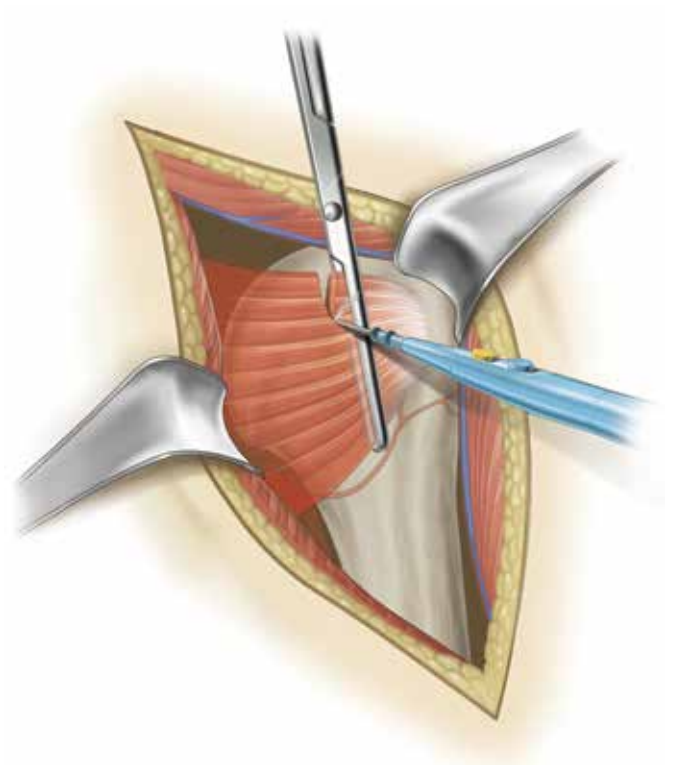

Figure 17

The subdeltoid space is mobilized with a blunt elevator. The clavicular head of the coracoacromial ligament is identified and spared, and the conjoined tendon is mobilized. A self-retaining retractor is placed with care to avoid excessive traction on the conjoined tendon (*Figure 16*). The coracoacromial ligament is identified and the subacromial space is mobilized with a blunt elevator.

The subscapularis tendon insertion on the lesser tuberosity is identified along with the rotator interval. The anterior humeral circumflex vessels along the inferior border of the subscapularis muscle, the "three sisters," are cauterized extensively, and the biceps tendon is palpated in its groove (*Figure 17*). The subscapularis tendon and the capsule are tenotomized 1 cm medial to the lesser tuberosity and tagged with #1 sutures.

An alternative approach is to elevate the subscapularis directly off the bone or elevate its insertion with a thin wafer of bone (1-2mm thick) using an osteotome. The choice is based on surgeon preference.

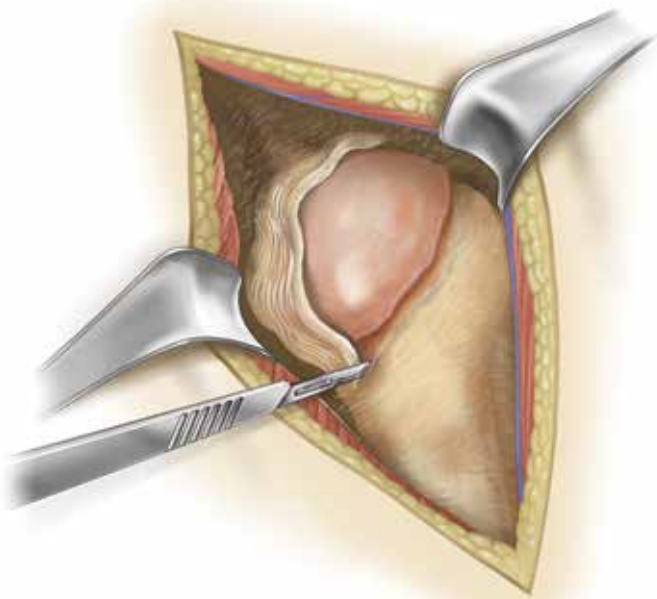

Figure 18

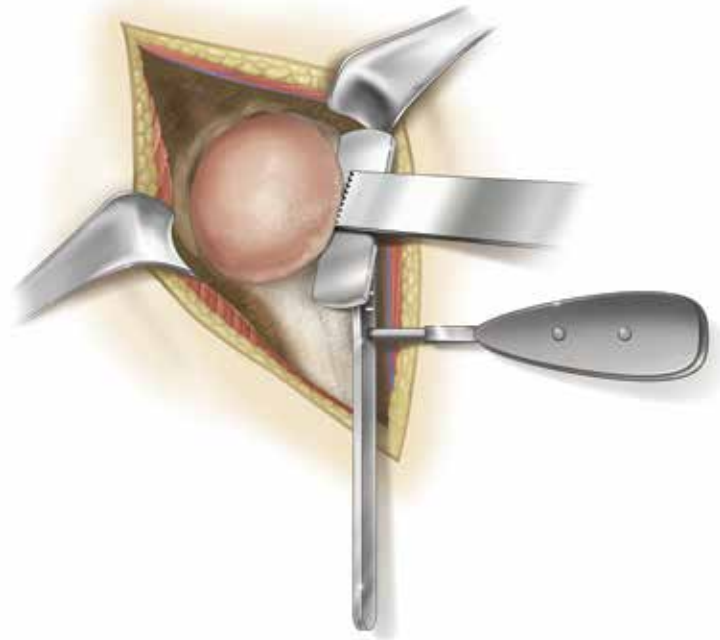

Figure 19

The rotator interval is divided in a lateral to medial direction up to the superior glenoid rim (*Figure 18*). With the humerus extended, adducted and externally rotated, the capsule is carefully dissected off the inferior humeral neck, protecting the axillary nerve inferiorly with a small blunt retractor placed just inferior to the capsule. The capsular releases should be performed to allow 90° of external rotation. The self-retaining retractor is then repositioned to retract the subscapularis. At this point, the humeral head can be dislocated.

Make the appropriate humeral head resection (*Figure 19*).

DETAILED STEPS PRIOR TO GPS

SURGICAL STEPS

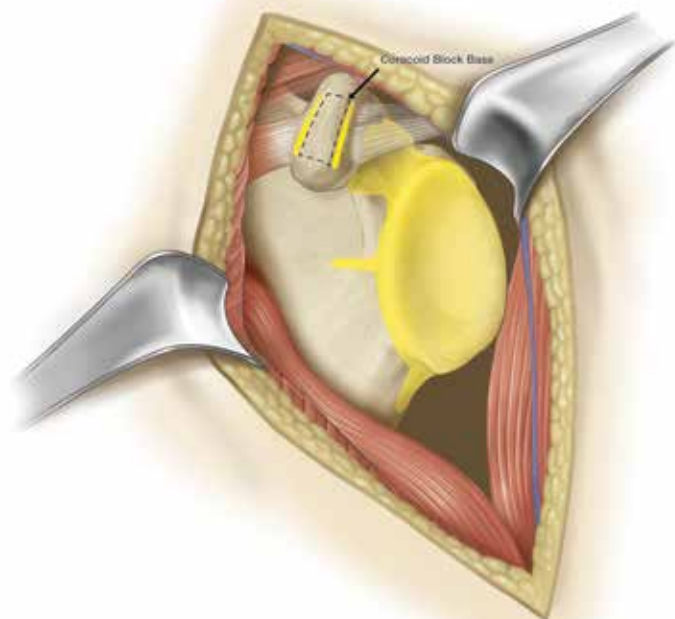

Figure 20

All areas in yellow must be exposed for acquisitions. All soft tissues and cartilage must be removed (Figure 20). Removal of the coracoacromial ligament is not required for acquisitions.

Note: Do not remove osteophytes or other bony landmarks before taking acquisitions, as these are necessary for proper use of the GPS system.

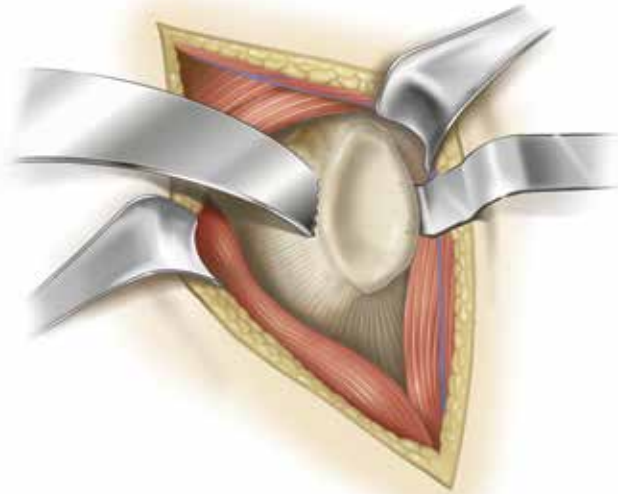

Figure 21

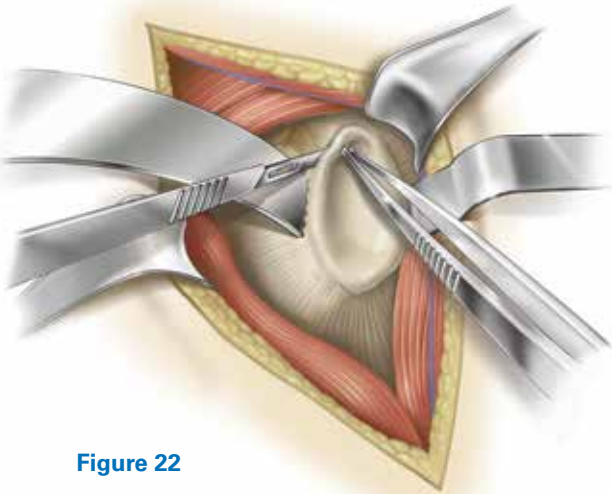

Figure 22

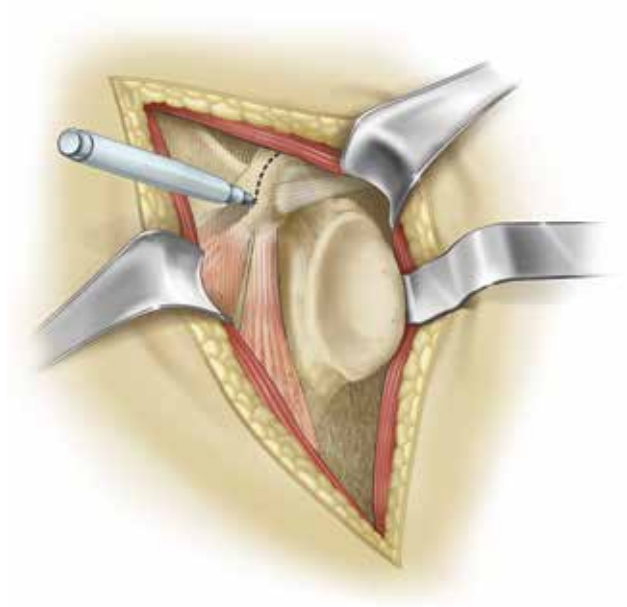

Figure 23

Place a retractor along the posterior border of the glenoid face (Figure 21) and retract the humeral head to expose the anterior glenoid edge. Dissect the anterior labrum (Figure 22).

Remove anterior labrum and capsule and clear soft tissue from glenoid face (Figure 23).

Carefully remove the hyaline cartilage from the glenoid surface using a Cobb elevator, ring curette, or comparable removal tool.

Note: It is critical to perform all the prep work on the humeral side (e.g. head resection) and extra glenoid exposure needed for the acquisition points before pinning the **Coracoid Block**. This is to minimize joint movement and risk of block fixation movement once the Coracoid Block has been pinned.

Continue exposing the glenoid by placing a blunt elevator under the subscapularis and releasing soft tissues attached to the anterior glenoid face. This will allow for better registration of the anterior glenoid border.

Some key steps to adequate glenoid exposure are as follows:

1. Fully mobilize subdeltoid space.
2. Release inferior capsule completely off the humerus while externally rotating the humerus.
3. Release anterior capsule and subscapularis from glenoid.
4. Excise labrum and release anterior and inferior capsule (protect axillary nerve).

DETAILED STEPS PRIOR TO GPS

SURGICAL STEPS

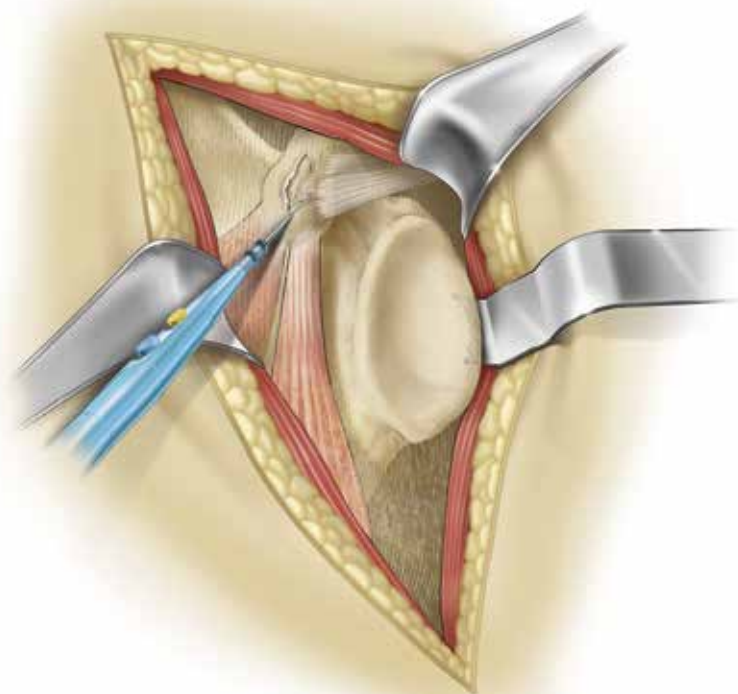

Figure 24

5. Resect adequate amount of humerus.
6. Stretch posterior capsule with humeral head retractor pushing humerus posterior to the glenoid.
7. If exposure is not adequate after steps 1-7, release posterior inferior capsule and triceps origin (must isolate and retract axillary nerve for this procedure).
8. If still poor exposure (very rare), then a posterior capsule release should be performed.

Clear fascia on superior coracoid using an electrocautery or blade (*Figure 24*). Using a marking pen or cautery, identify the axis of the coracoid.

It is important to note the short head of the biceps inserts near the tip of the coracoid and the pectoralis minor can wrap over the bone from the anterior side. Portions of these tissues may need to be removed to gain access to the bone.

Identify any soft tissue on the inferior portion of the coracoid and around the coracoid base. Remove this soft tissue.



Figure 25



Figure 26



Figure 27

Once the coracoid is exposed, the Tracker block should be affixed to the bone ensuring the Tracker post is oriented toward the camera. Note the camera can maintain visibility up to 160°, but more direct focus leads to better signal strength.

Note: For the first cases, extend the incision above the coracoid until it is determined how much exposure is needed for block placement.

Note: Before pinning the Coracoid Block, attach the G Tracker and hold the block up to where it will be pinned to the coracoid. This ensures Tracker visibility to the station before pinning, as it will not be able to be moved afterwards.

Coracoid anatomy can vary so make sure that the threaded coracoid pins have solid bone purchase with the first try. This

can be achieved by palpating or aiming with a small K-wire through the posterior angled pin hole.

Step 1: Position the block on top of the coracoid so it is in line with the axis of the coracoid and so the trajectory of the screws will have good bone purchase, taking special care to ensure the posterior 30 degree angled pin will shoot down the base of the coracoid (Figure 25).

Step 2: Insert the short pin into the lateral slot in the block until hand tight. Aim for the middle of the slot so the block can self-adjust when the long pin is inserted (Figure 26).

Step 3: Insert the long pin into the medial hole of the block down the neck of the coracoid until hand tight. Carefully retighten pins, if necessary (Figure 27).

DETAILED STEPS PRIOR TO GPS

SURGICAL STEPS



Figure 28



Figure 29

The block is now fixated and ready for Tracker attachment (Figures 28 and 29).

Note: If the bone quality is dense, it can help to pierce the top cortex on the coracoid through the block holes with a small 1.6mm K-wire (no larger) before inserting the threaded pins.

Note: Screws should be tightened by hand (to confirm the G Tracker fixation).

Note: It is imperative to keep the coracoid block free of soft tissue tension throughout the case, and to keep a retractor behind it at all times. If there are assistants holding retractors, it is important to not let the tissue encroach on the base of

the block. It is a good idea to gently feel the fixation of the block throughout each navigated step, to ensure it is still robustly fixated.

Use a gelpi, or similar self-retaining retractor, vertically to keep the coracoid block free of soft tissue tension. The retractor can be clamped to the patient's head drapes to enable hands-free retraction.

Note: If robust fixation is not achieved the first time pinning the Coracoid Block to the bone, it is not advised to attempt repinning the block, creating additional holes in the bone.

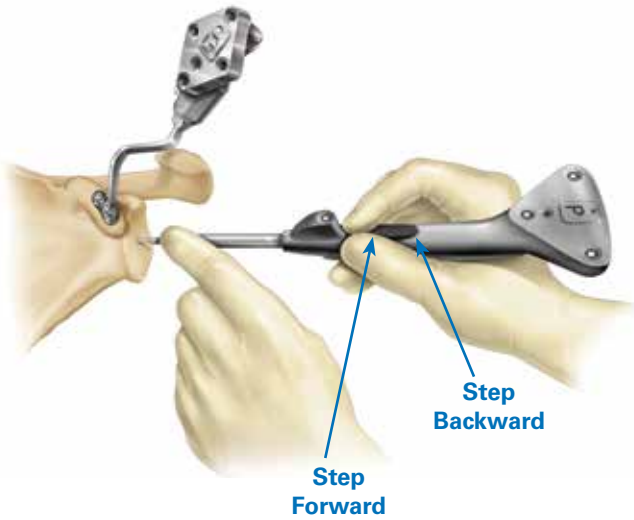

Figure 30

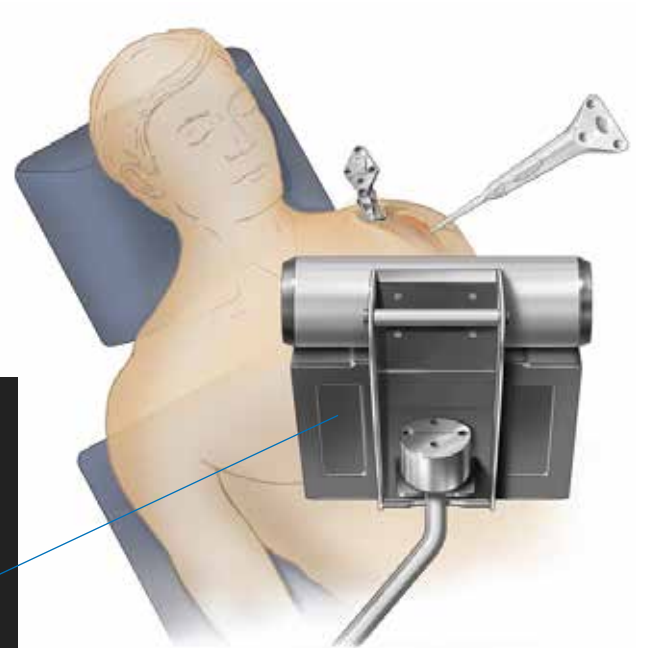
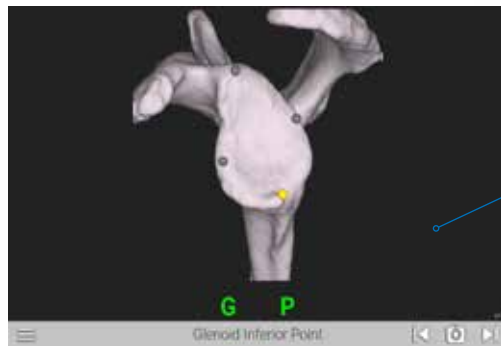

Figure 30b

PROBE ORIENTATION

Trackers may be paired before or after selecting the patient information. Before beginning registration, ensure that the G Tracker is completely seated on the coracoid block. Hold the Probe Tracker (P) with the index finger on the Forward button making sure not to obstruct the IR LED between the button and the probe tip (Figure 30a).

Always make sure the probe tip is on the anatomic landmark. Press and release the Forward button to begin registering acquisitions (Figure 30b).

For patch registration, place the probe tip on the anatomic landmark, **press and release** the Forward button ensuring the Probe is touching bone, **then** paint the anatomic reference shown on the screen using an S-like pattern. The button does not need to be held down for acquisitions. To return to previous step or re-do an acquisition, rapidly double click the Back button on the probe. The probe must be visible in order for the buttons to be selected.

DETAILED STEPS PRIOR TO GPS

SURGICAL STEPS

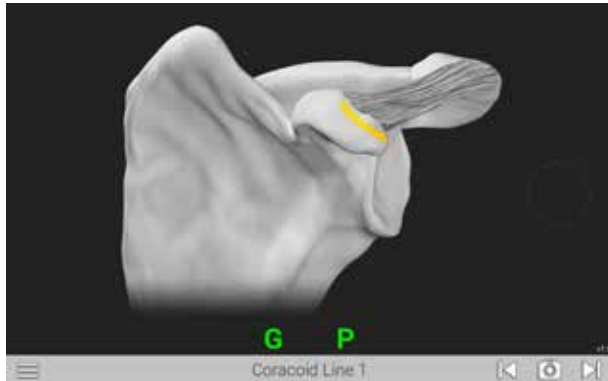

Figure 31a: Line anterior of coracoid block

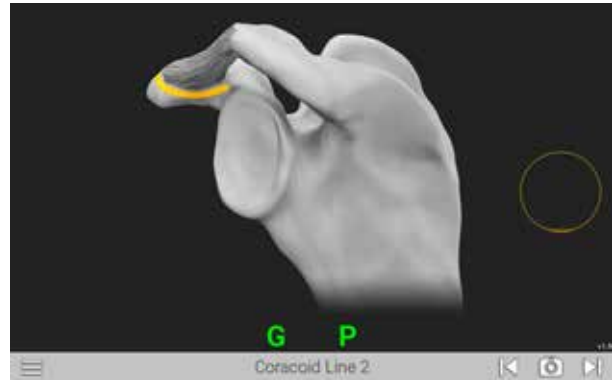

Figure 31b: Line posterior of coracoid block

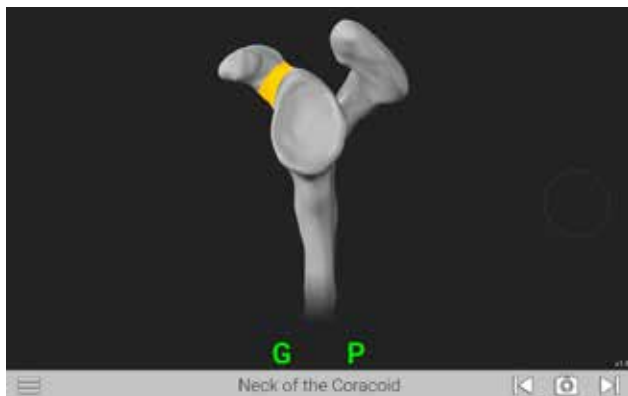

Figure 31c: Neck of coracoid

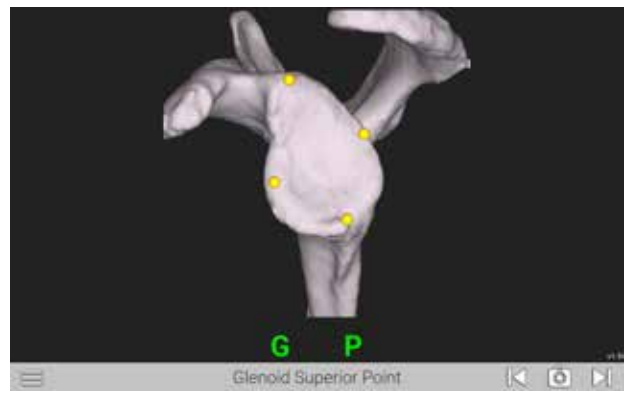

Figure 31d: Four points on glenoid face: superior, inferior, anterior, posterior

ACQUISITIONS

Using a two handed approach, probe the acquisition points listed on each screen as guided by the system (*Figures 33a-i*). When the probe tip is in contact with the bony area to be acquired, press the Forward button on the probe handle. The system will begin to acquire points as soon as the button is pressed. The button does not need to be held down to continue acquiring points, it only needs to be pressed once per step. Move the probe tip across the bony surface until the system has acquired enough points and moves to the next step. Take care to keep the probe in contact with bone the entirety of the acquisition process, and try to capture as much surface area as possible in each acquisition patch.

If the probe tip is lifted off or if incorrect points are acquired, the surgeon can re-do the acquisitions by clicking the Backwards button on the probe handle twice in succession.

On all points on the side walls of the glenoid face (inferior scapular neck, anterior lines), probe as medial on the bone as possible to aid in registration.

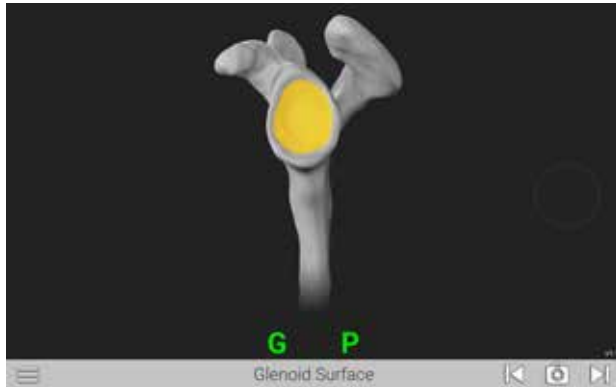

Figure 31e: Paint glenoid surface

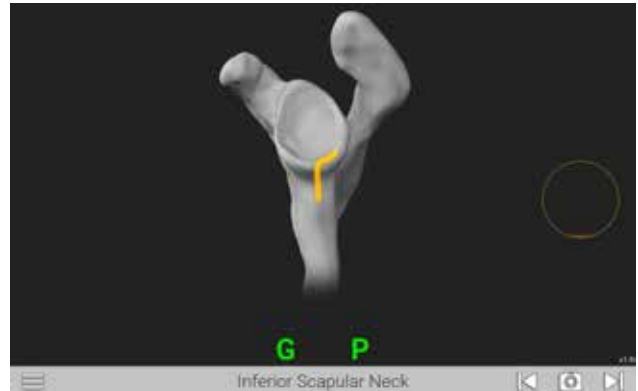

Figure 31f: Inferior glenoid neck

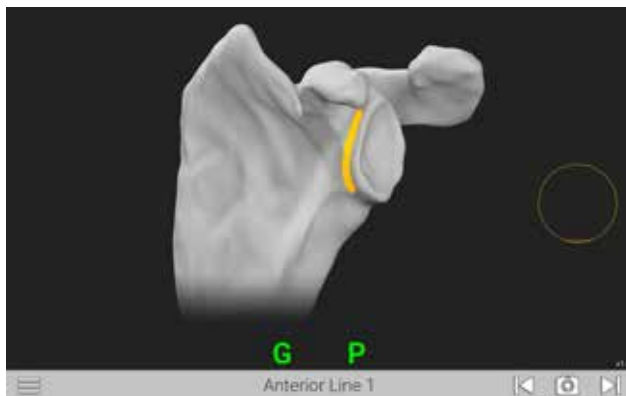

Figure 31g: Superior/Inferior line on scapular wall anterior of glenoid face

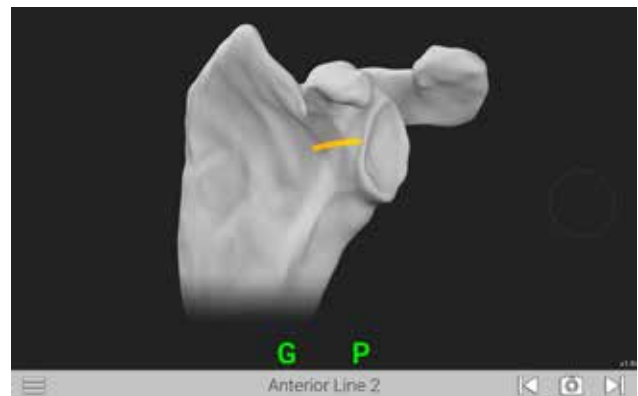

Figure 31h: Medial/Lateral line on scapular wall anterior of glenoid face

Note: Take care to sufficiently expose each acquisition area of all soft tissue and cartilage before probing points, so only bone is exposed and probed. Do not trim any osteophytes before taking acquisitions, even if they are a part of a specific acquisition area. The CT scan and 3D scapula model see only bone, so the surgeon must probe only bone for an accurate registration.

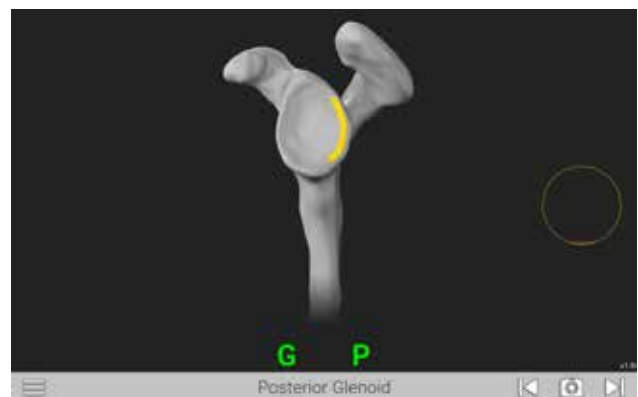

Figure 33i: Line on posterior face of glenoid

DETAILED STEPS PRIOR TO GPS

SURGICAL STEPS

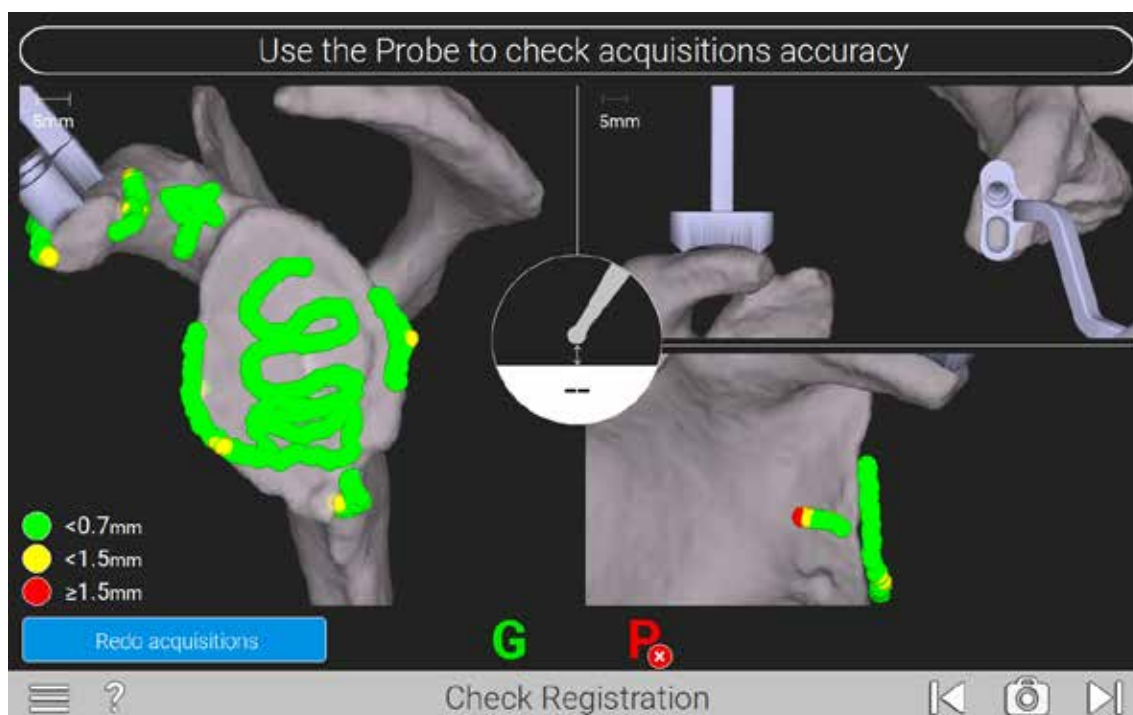

Figure 32

The system will digitize the acquisitions and generate a color map of the points for verification (Figure 32).

- Green points signify that acquired points match digital reconstruction within .7mm or less.
- Yellow points signify that acquired points vary from .7 to 1.5mm from digital reconstruction.
- Red points signify that acquired points vary more than 1.5mm from the digital reconstruction.

Surgeons should strive for all green points in the digitization. It is important to identify which acquisition areas may be inaccurate based on the color and locations of the points. For example, if there is a trail of yellow and red dots at the end of

an acquisition area that extends off the surface of the bone, assume that the probe tip was lifted off of the bone surface before all points were acquired, and points were acquired in empty space.

Once all acquisitions obtained are green, the surgeon may verify accuracy by spinning around the scapula via the screen. This can also be achieved by using the mouse, clicking and then rotating the scapula. If acquisitions are accurate enough, an advance arrow will appear at the bottom right.

Note: Use the probe tip to touch different surfaces on the scapula to see the probe tip show up on the screen; this will verify the probe is registering where the surgeon is physically touching the bone.

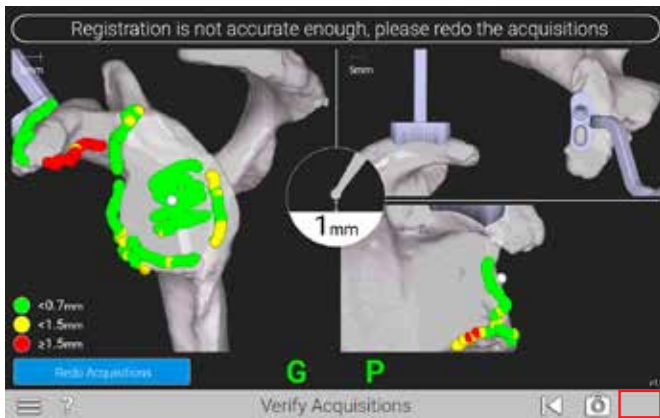

Figure 33

If acquisitions are not accurate enough to continue, the “Advance” button will be missing on the bottom right of the screen, as seen in the top image of *Figure 33*. Using the Verify Acquisitions screen, identify which acquisitions need to be re-done based on the color map of the acquisitions.



Figure 34

To continue re-doing acquisitions, select “Re-do” and then select the landmarks to re-do (*Figure 34*).

Note: If there are several areas where the acquisition map is red, select the Select All button to re-do all acquisitions.

DETAILED OPERATIVE TECHNIQUE

PRIMARY SHOULDER

PRIMARY SHOULDER

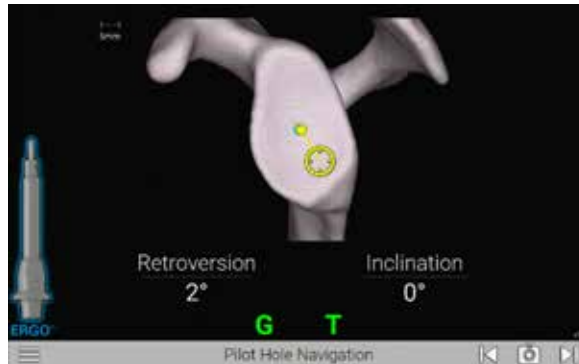

Figure 35



Figure 36

STEP 1: PILOT TIP DRILL

If not already done, carefully attach the **T Tracker** to the **Pilot-tip Driver (531-55-00)**. Ensure the tracker is fixated on the tracker post with the tracker face aiming in the direction of the pilot tip of the driver.

Note: It is helpful to utilize a “tug test” both rotationally and vertically to ensure the tracker is properly fixated on the instrument and to ensure it does not move.

Use the Pilot-tip Driver to drill the glenoid pilot hole (Figure 36).

Follow the on-screen guidance to orient the GPS Ergo Driver according to the plan (Figure 37). Both the pilot hole and k-wire insertion screens are guided in a similar fashion with real-time feedback on the position of the Driver and K-wire Guide.

- For positioning of the drill, the tip of the drill is indicated by a yellow dot (Figures 35 and 37).
- The planned position is indicated by a blue dot (Figure 35).

The orientation is guided by the circular cross-hair indicator. When the target is perfectly aligned, the screen will display the cross-hair superimposed on the yellow dot (Figure 37).

Press the Next arrow to proceed.

Note: At any point in the procedure, the surgeon may use the probe to advance to the next screen by pressing the forward button twice while facing the camera.

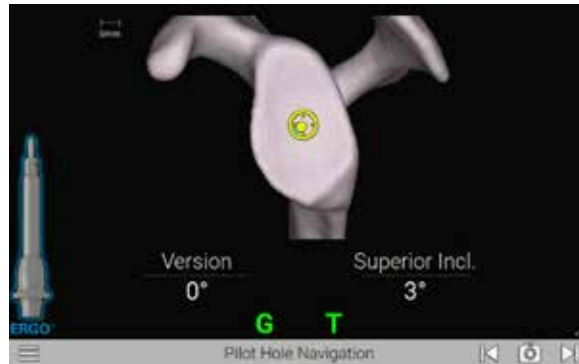

Figure 37

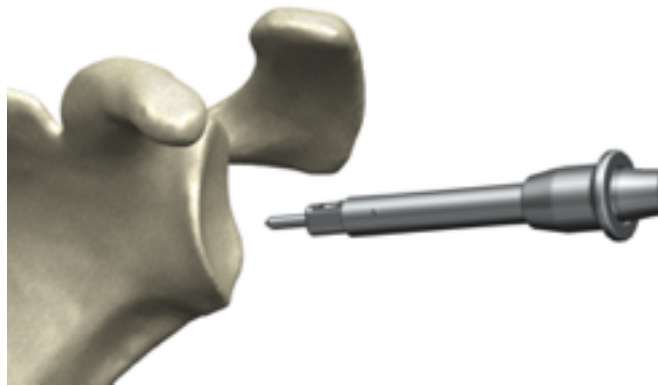

Figure 38

Note: Avoid applying a bending force to the modular driver or using the modular driver to retract the humeral head as this may cause fracture of the pilot tip feature.

Note: The numbers shown for version and inclination are displayed according to the preoperative plan.

WARNING: Don't assemble or disassemble devices in the surgical field as components may become loose.

The surgeon may deviate from this plan if desired. This screen includes an image of the orientation that is synchronized with the CT scan slices to visualize the cortices. Follow the on-screen guidance to drill the center hole.

DETAILED OPERATIVE TECHNIQUE

PRIMARY SHOULDER

PRIMARY SHOULDER

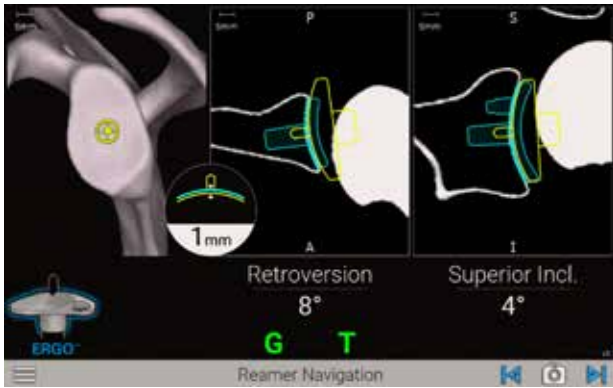

Figure 39a

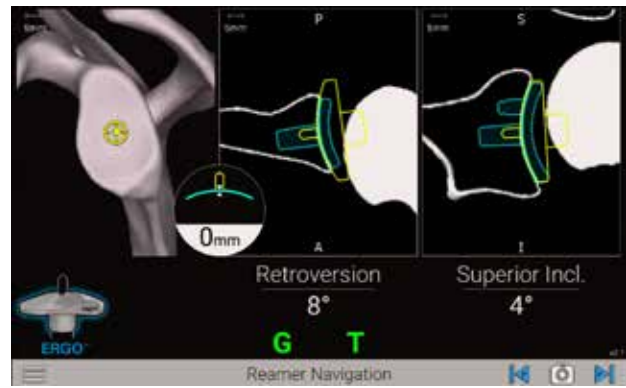

Figure 39b

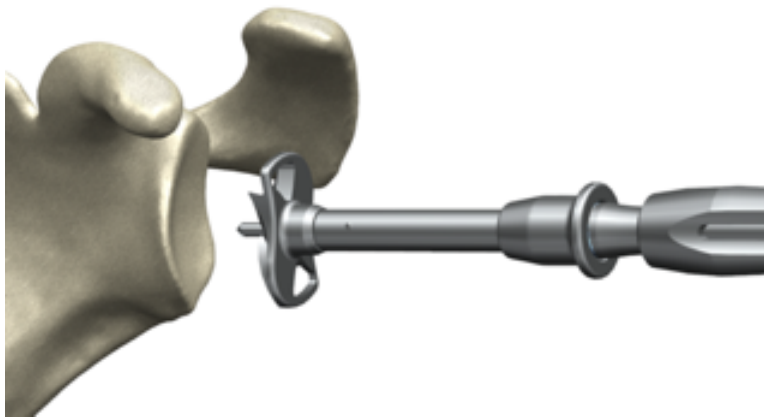

Figure 40

STEP 2: GLENOID REAMING

Select an Anatomic Reamer per the Equinox Ergo surgical technique 718-01-30 and attach it to the **Pilot-tip Driver** (Figure 40).

Follow the on-screen guidance to ream according to the plan (Figures 39a and 39b). The reaming screen is guided in a similar fashion to the pilot-hole guidance, with real-time feedback on the position of the pilot-tip and reamer curvature relative to the planned depth.

Press the Next arrow to proceed and detach the reamer.

Note: When preparing for augmented glenoid components, be aware that the drilling axis is different from the reaming axis. The system accounts for this; the surgeon does not need to adjust for this mismatch.

	Implant	Implant Length (mm)	Drill to Use	Drill Flute Length (mm)	Overdrill Amount (mm)
ANATOMIC	Cage Glenoid	14.5	STD	19.3	4.8
	Cage Glenoid - 8° Augment	15.9	STD	19.3	3.4
	Pegged Glenoid - Standard	11.7	STD	19.3	7.6
	Pegged Glenoid - 8° Posterior Augment	11.6	STD	19.3	7.7
	Pegged Glenoid - 16° Posterior Augment	12.2	STD	19.3	7.1
	Keeled	16	STD	19.3	3.3

**GPS Ergo Center Drills are coated to indicate size, reflected in the cell color. These color indications are also present on the relevant GPS screens. The standard GPS Ergo Drill is gold coated.*

Table 1

DETAILED OPERATIVE TECHNIQUE

PRIMARY SHOULDER

PRIMARY SHOULDER

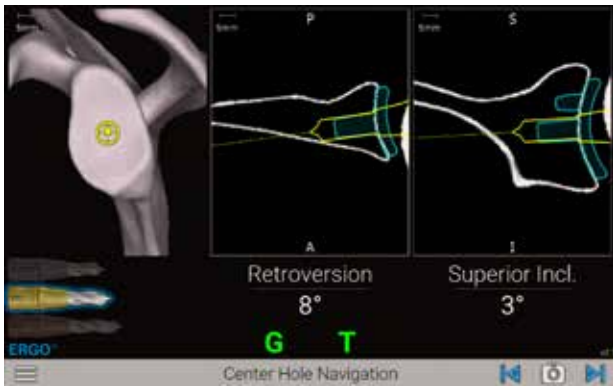

Figure 41a

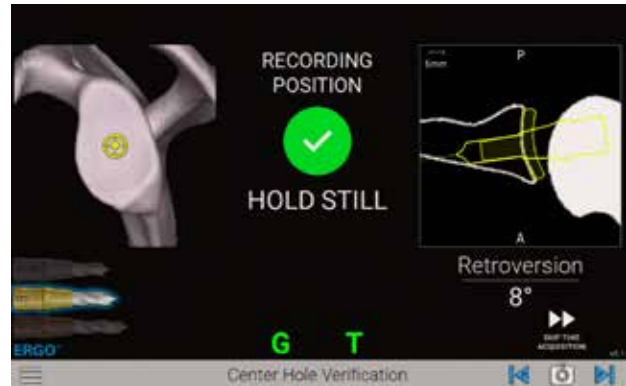

Figure 41b

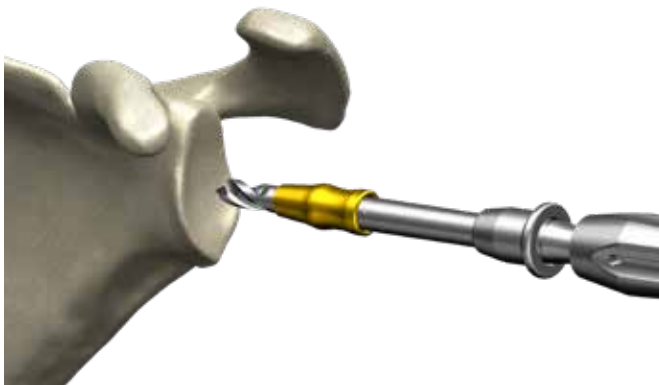

Figure 42

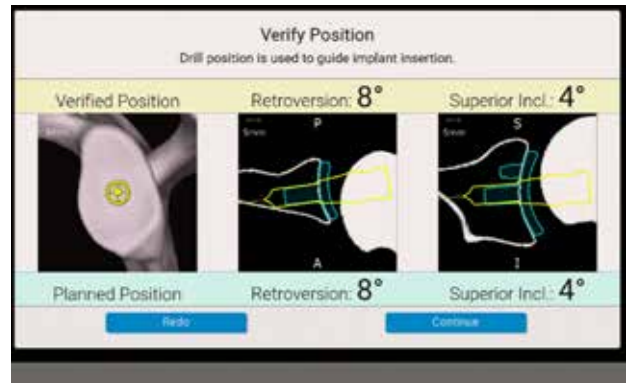

Figure 43

STEP 3: CENTER HOLE

Attach the corresponding GPS Ergo Center Drill to the Pilot-tip Driver. Be sure to use the correct drill for the appropriate implant by referencing the bottom-left portion of the GPS screen, which highlights the correct drill. Refer to the indicated size on screen or *Table 1*.

DRILLING

Drill the center cage hole for the Anatomic Glenoid Implant using the on-screen guidance with the cross-hairs, as used in the previous steps. Once the drill is fully seated, the surgeon may advance to the next screen **but do not take the drill out of the bone** (Figures 41a and 41b).

VERIFY POSITION

With the drill still fully seated in the bone, hold the Pilot-tip Driver in-place over the drilled axis to capture the position of the planned implant. The system will adjust the original plan to where the drill was actually placed. The system will advance to the next step automatically, accurately recording the drill axis location and orientation (Figure 41b).

A pop-up will appear showing the verified position of the drill vs. the planned position. If the surgeon would like to re-do the digitization, press Re-do. If the surgeon accepts the digitization, press Continue (Figure 43).



Figure 44



Figure 45

STEP 4: PERIPHERAL PEG DRILL GUIDANCE

PERIPHERAL PEG DRILL

Remove the T Tracker from the Pilot-tip Driver and attach it to the Zimmer-Hudson adapter. Ensure Tracker LEDs are facing the direction of the indicated shoulder with the laser marking on the post under the Tracker (i.e. left for left, right for right).

Note: It is helpful to utilize a “tug test” both rotationally and axially to ensure the tracker is properly fixated on the instrument and to ensure it does not move.

Attach the male end of the Zimmer-Hudson adapter to the Zimmer-Hudson handle, and the female end of the Zimmer-

Hudson adapter to the appropriate Peripheral Peg Drill Guide for the planned anatomic glenoid implant, with the drill guide size marking reading right side up in the direction of the Tracker. Ensure that the drill guide bottoms-out and fully engages with the Zimmer-Hudson adapter, and that the collar of the Zimmer-Hudson adapter fully deploys over the male end of the Zimmer-Hudson drill guide (Figure 44).

Next, from the **Ergo kit**, attach the Peripheral Peg Drill (315-52-62) to the Peripheral Peg Driver (315-52-01) (Figure 45).

Attach the Peripheral Peg Driver to a powered drill.

DETAILED OPERATIVE TECHNIQUE

PRIMARY SHOULDER

PRIMARY SHOULDER

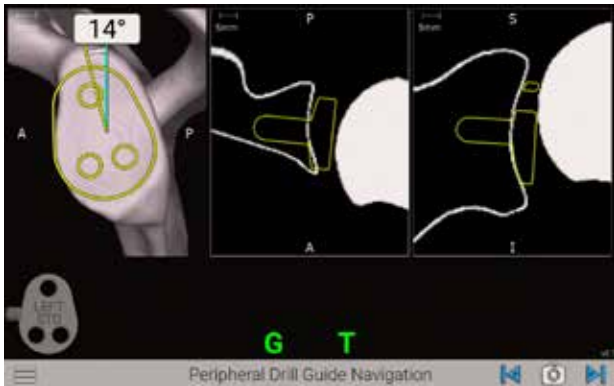

Figure 46a

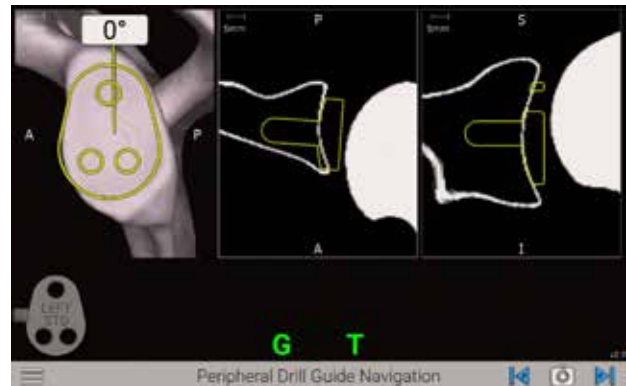

Figure 46b

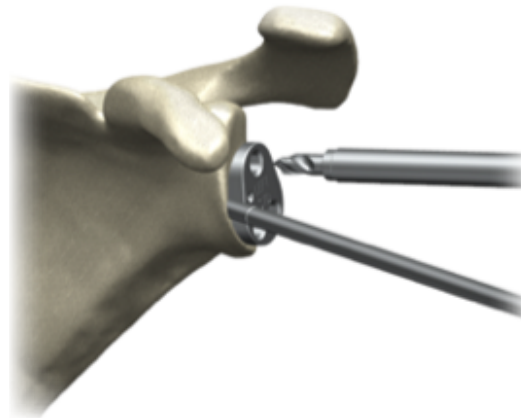

Figure 47

With one hand, hold the Peripheral Drill Guide and Zimmer Hudson Adapter assembly with the TTracker attached. With the other hand, insert the Peripheral Peg Drill into the Peripheral Peg Drill Guide (Figure 47).

Use the angle measurement on the screen to adjust the Peripheral Peg Drill Guide to the plan (Figures 46a and 46b). The surgeon will want to rotate the Peripheral Peg Drill Guide to match the yellow line with the blue line. The degrees

shown on screen represent the variability of the angle to plan, **not the overall planned rotation of the implant.**

Drill each of the 3 peripheral peg holes, then remove all drills with guide. When finished drilling peripheral peg holes, remove the tools and advance the screen.

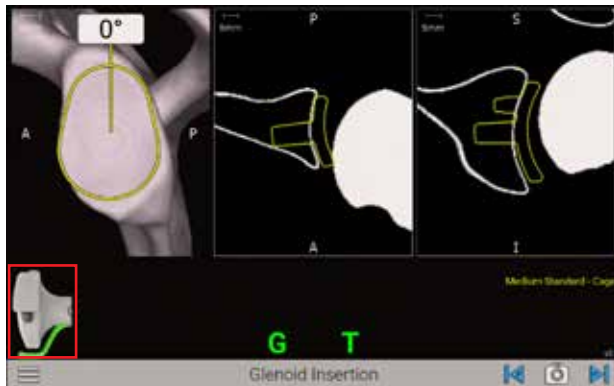

Figure 48



Figure 49



Figure 50



Figure 51

STEP 5: IMPLANT INSERTION

IMPLANT INSERTION

Attach the appropriate anatomic Glenoid Inserter Impactor Tip to the GPS Impactor Handle. After removing the T tracker from the Zimmer-Hudson adapter from the prior step, place it onto the GPS Impactor Handle, again ensuring left for left, right for right.

Note: It is helpful to utilize a “tug test” both rotationally and vertically to ensure the tracker is properly fixated on the instrument and to ensure it does not move.

Only Equinox Ergo Impactor Tips are compatible (315-54-02/03/04/05 and 315-55-02/03/04/05).

Use the onscreen prompts to place and impact the implant according to the plan (Figures 48 and 49). The screen will indicate the implant being impacted and it will show the corresponding color inserter to use for that specific implant.

Again, the degrees shown on screen represent the variability of the angle to plan, not the overall planned rotation of the implant. Once implant is fully seated, **do not remove the impactor and inserter.**

Note: Ensure the superior portion of the implant is always oriented in the same direction as the Tracker (Figures 50 and 51).

WARNING: Don't assemble or disassemble devices in the surgical field as components may become loose.

DETAILED OPERATIVE TECHNIQUE

PRIMARY SHOULDER

PRIMARY SHOULDER



Figure 52

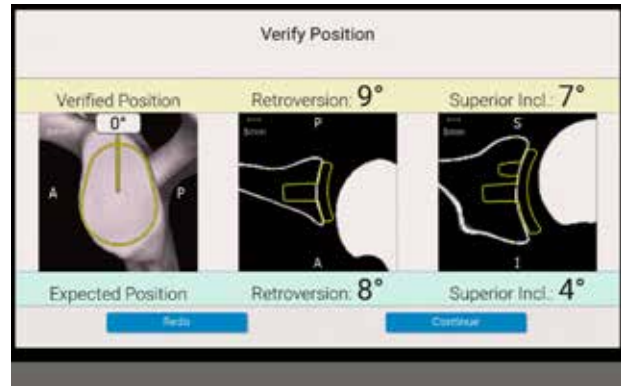

Figure 53

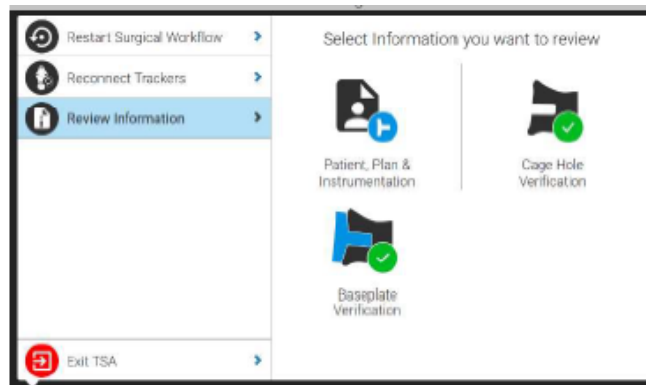

Figure 54

VERIFY POSITION

After implanting, hold the Impactor Handle and Inserter still and flush against the implant face. Press the Next button on the screen to capture the position of the implant placement (Figure 52).

A pop-up will appear showing the verified position of the implant vs. the planned position (Figure 53). If the surgeon would like to redo the digitization, press Re-do. If the surgeon accepts the digitization, press Continue to capture the verified implant placement. Once the navigated part of the procedure is complete, remove the G Tracker and Coracoid Block.

Complete remaining surgical steps per Equinox Ergo surgical technique. At the end of the case, the Exactech representative will run GetStationLog on the GPS system to upload the case. Make sure to upload all cases to GPSWeb. Case reports showing the final verified implant placement are available on the surgeon's GPS Web account.

Note: You can always review the plan by pressing the menu button and selecting "Review Information" from the pop-up menu on the left (Figure 54).

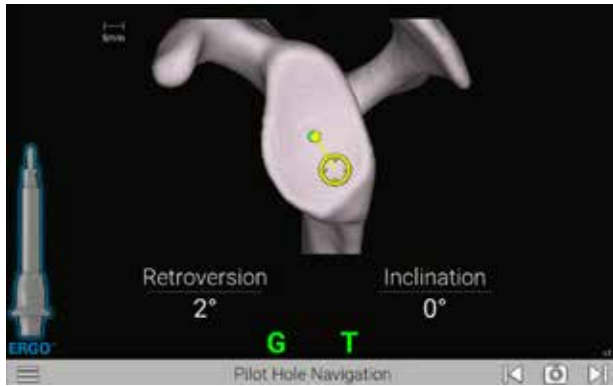

Figure 55a

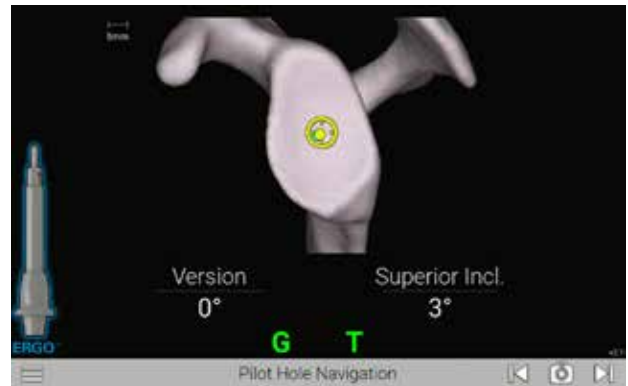

Figure 55b

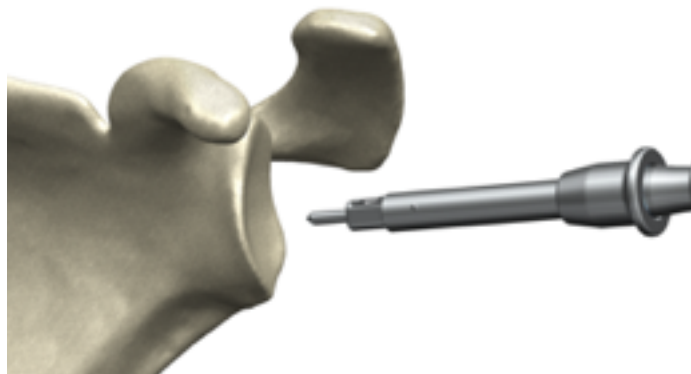

Figure 56

STEP 1: PILOT TIP DRILL

Attach the **TTracker** to the **Pilot-tip Driver (531-55-00)**.

Use the Pilot-tip Driver to drill the glenoid pilot hole (Figure 56).

Follow the on-screen guidance to place the components according to the plan (Figures 55a and 55b). Both the pilot hole and k-wire insertion screens are guided in a similar fashion with real-time feedback on the position of the Driver and K-wire Guide.

Press the Next arrow to proceed.

- For positioning of the Drill, the tip of the Drill is indicated by a yellow dot (Figures 55a and 55b).
- The planned position is indicated by a blue dot (Figure 55a).

The orientation is guided by the circular crosshair indicator. When the target is perfectly aligned, the screen will display the crosshair superimposed on the yellow dot (Figure 55b). Follow the on-screen guidance to drill the center.

Note: Avoid applying a bending force to the modular driver or using the modular driver to retract the humeral head as this may cause fracture of the pilot tip feature.

Note: The numbers shown for version and inclination are displayed according to the preoperative plan.

Note: The plan may not necessarily read 0° version and 0° inclination. The surgeon may deviate from this plan if desired. This screen includes an image of the orientation that is synchronized with the CT scan slices to visualize the cortices.

WARNING: Don't assemble or disassemble devices in the surgical field as components may become loose.

DETAILED OPERATIVE TECHNIQUE

REVERSE SHOULDER

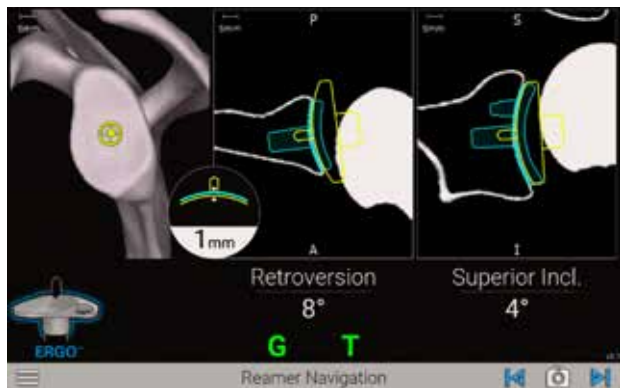

Figure 57a

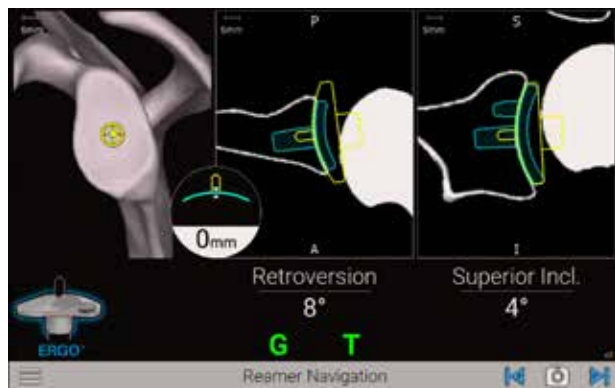

Figure 57b

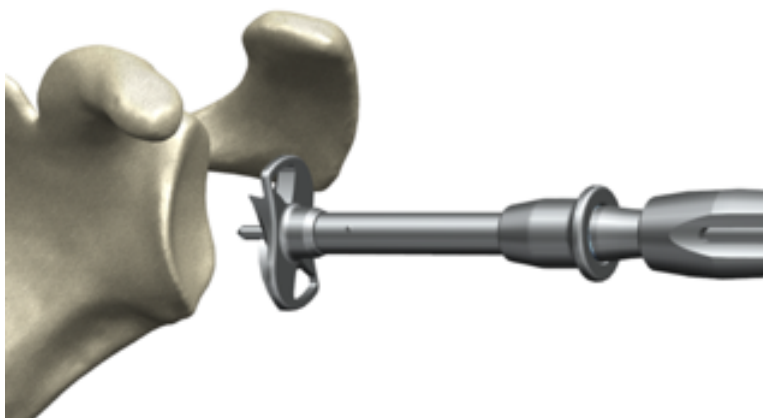

Figure 58

STEP 2: GLENOID REAMING

Select a **Reverse Reamer** per the Equinox Ergo surgical technique 718-01-30 and attach it to the **Pilot-tip Driver** (Figures 57a and 57b).

Follow the on-screen guidance to ream according to the plan (Figure 58). The reaming screen is guided in a similar fashion to the pilot-hole guidance, with real-time feedback on the position of the pilot-tip and reamer curvature relative to the planned depth.

Press the Next arrow to proceed and detach the reamer.

Note: When preparing for augmented glenoid components, be aware that the drilling axis is different from the reaming axis. The system accounts for this; the surgeon does not need to adjust for this mismatch.

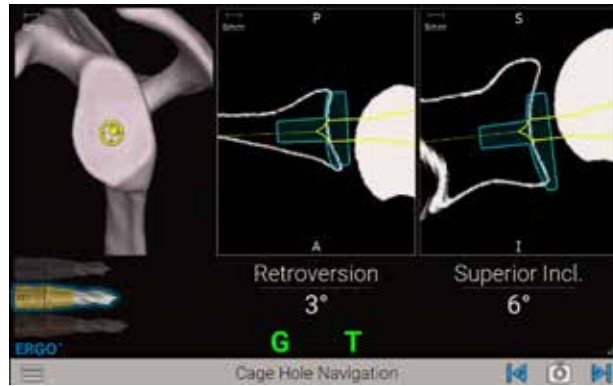

Figure 59

	Implant	Implant Length (mm)	Drill to Use	Drill Flute Length (mm)	Overdrill Amount (mm)
REVERSE	Glenoid Baseplate - Standard	16.8	STD	19.3	2.5
	Glenoid Baseplate - 10° Superior Augment	18.3	STD	19.3	1
	Glenoid Baseplate - 8° Posterior Augment	16.8	STD	19.3	2.5
	Glenoid Baseplate - 10mm Extended Cage	26.8	EXT	25.3	-1.5
	Glenoid Baseplate - Superior Posterior Augment	23.3	EXT	25.3	2
SMALL REVERSE	Small Glenoid Baseplate - Standard	13.1	SHORT	15.6	2.5
	Small Glenoid Baseplate - 10° Superior Augment	14.3	SHORT	15.6	1.3
	Small Glenoid Baseplate - 8° Posterior Augment	13.9	SHORT	15.6	1.7
	Small Glenoid Baseplate - 10mm Extended Cage	23.1	EXT	25.3	2.2
	Small Glenoid Baseplate - Superior Posterior Augment	18	STD	19.3	1.3

- Extended Drill
- Standard Drill
- Short Drill

*GPS Ergo Center Drills are coated to indicate size, reflected in the cell color. These color indications are also present on the relevant GPS screens. The small GPS Ergo drill is left uncoated, the standard GPS Ergo drill is gold coated, and the extended GPS Ergo drill is rose-gold coated.

Table 2

DETAILED OPERATIVE TECHNIQUE

REVERSE SHOULDER

REVERSE SHOULDER

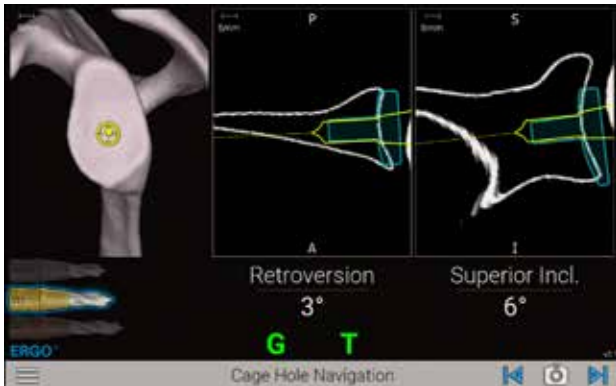

Figure 60a

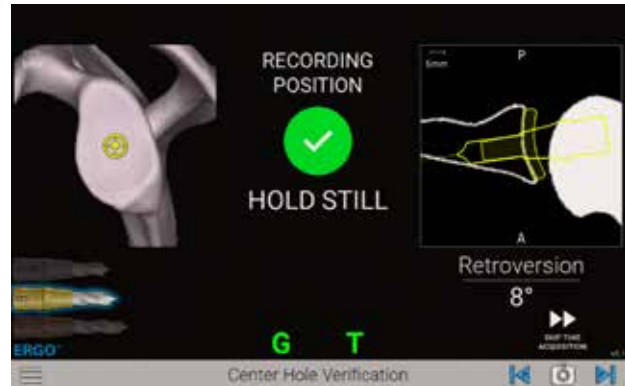

Figure 60b

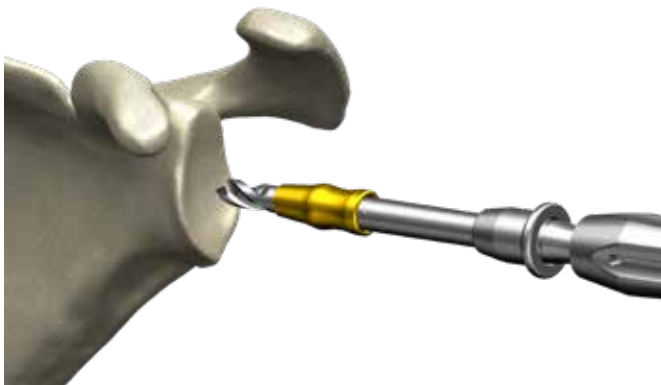

Figure 61

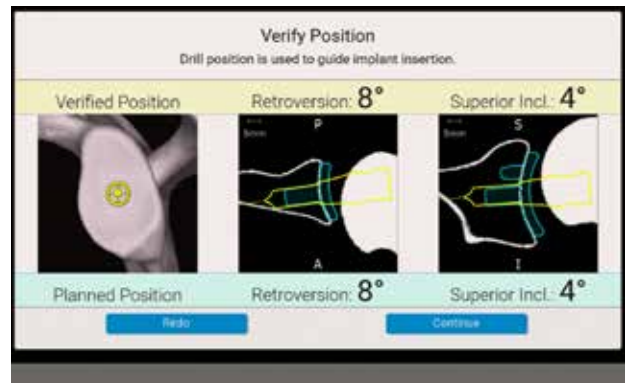

Figure 62

STEP 3: CAGE DRILL GUIDANCE

Attach the corresponding **GPS Ergo Center Drill** to the **Pilot-tip Driver** (Figure 59). Be sure to use the correct drill based on the implant being used. Refer to the indicated size on screen (Table 2).

DRILLING

Drill the center cage hole for the planned **Reverse Glenoid Implant** (Figure 61).

Once the drill is fully seated, the surgeon may advance to the next screen, but do not take the drill out of the bone.

VERIFY POSITION

With the drill still fully seated in the bone, hold the Pilot-tip Driver in place over the drilled axis to capture the position of the planned implant (Figure 60b). The system will adjust the original plan to where the drill was actually placed. The system will advance to the next screen automatically, accurately recording the drill axis location and orientation (Figures 60a and 60b).

A pop-up will appear showing the verified position of the drill vs. the planned position (Figure 62). If the surgeon would like to re-do the digitization, press Re-do. If the surgeon accepts the digitization, press Continue.

After removing the T-tracker from the GPS Ergo Driver, carefully place it on the GPS Impactor Handle.



Figure 63

Baseplate Inserter Chart



GPS Impactor Handle

Compatible Baseplate Inserters



<p>321-19-13 — Ergo Inserter (Pilot)</p> 	<p>321-19-14 — Ergo Inserter</p> 
<p>321-35-23 and 321-35-24 — Ergo Small Reverse Baseplate Inserter</p> 	

Figure 64

Attach the appropriate corresponding reverse baseplate Impactor Tip to the GPS Impactor Handle (Figure 63). Attach the T Tracker to the Handle (ensuring left for left, right for right).

Note: It is helpful to utilize a “tug test” both rotationally and vertically to ensure the tracker is properly fixated on the instrument and to ensure it does not move.

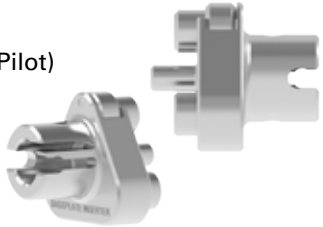
WARNING: Don't assemble or disassemble devices in the surgical field as components may become loose.

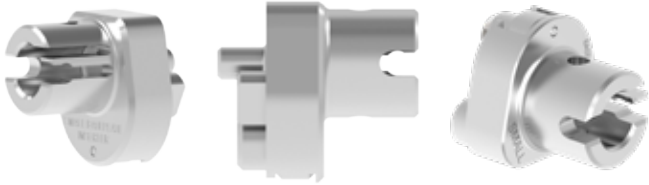
DETAILED OPERATIVE TECHNIQUE

REVERSE SHOULDER

REVERSE SHOULDER

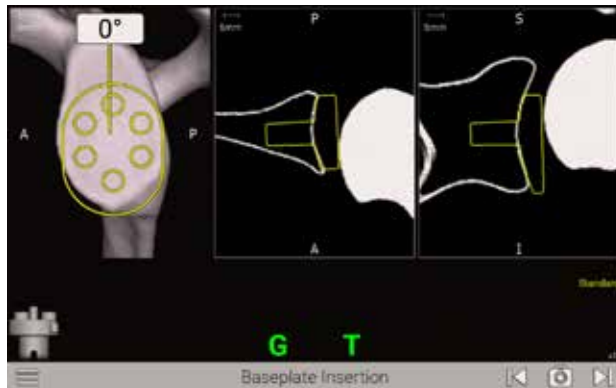

Figure 65



Figure 66a



Figure 66b

STEP 4: IMPLANT INSERTION

IMPLANT INSERTION

The blue line represents the planned angle of the implant's rotation and will always be facing vertically. Because of this, the surgeon might notice that the scapula is rotated on this step.

Note: Ensure the superior portion of the implant is always oriented in the same direction as the Tracker (Figures 66a and 66b).

Align the blue and yellow dots as done previously, while referencing the angular measurements, to impact the implant based on the plan (Figure 65).

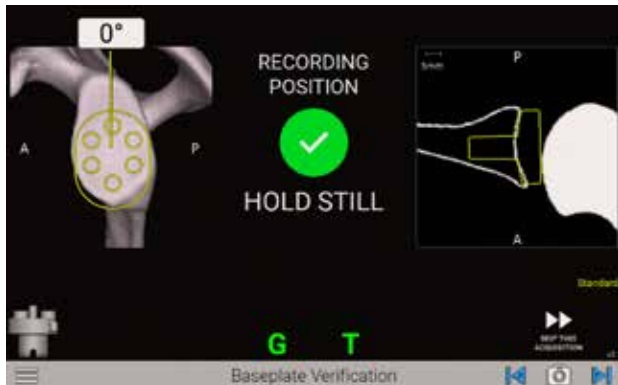

Figure 67

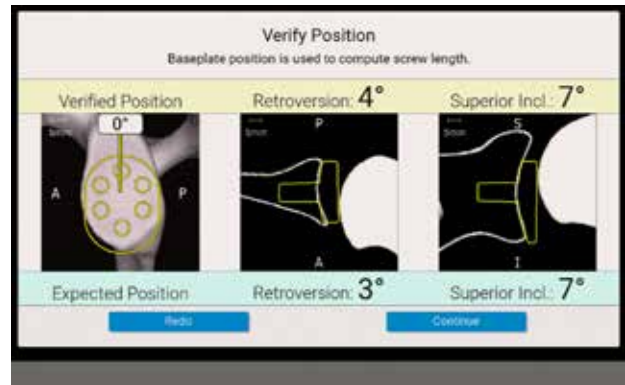

Figure 68

VERIFY POSITION

After implanting, hold the Impactor Handle and Inserter still and flush against the implant face. Press the Next button on the screen to capture the position of the implant placement, which will adjust the original plan to where the surgeon placed the implant (Figure 67).

A pop-up will appear showing the verified position of the implant vs. the planned position (Figure 68). If the surgeon would like to re-do the digitization, press Re-do. If the surgeon accepts the digitization, press Continue.

After removing the T-tracker from the GPS Impactor Handle, carefully place it on the GPS Ergo Driver.

Note: It is helpful to utilize a “tug test” both rotationally and axially to ensure the Tracker is properly fixated on the instrument and to ensure it does not move.

DETAILED OPERATIVE TECHNIQUE

REVERSE SHOULDER

REVERSE SHOULDER



Figure 69



Figure 70

STEP 5: COMPRESSION SCREW NAVIGATION

Attach the **Ergo GPS 3.2mm Drill** to the **Driver** (Figure 69). The Ergo GPS 3.2mm Drill is sterile packed specifically for use with GPS. Note that the sterile-packed GPS Ergo Reverse drill bit does not have the colors indicated on the drill. Re-attach the TTracker onto the GPS Driver.

Next, clip the **GPS 3.2mm Drill Guide** to the **Ergo GPS 3.2mm Drill** (Figure 70). The surgeon can use the standard Ergo Drill Guide and confirm depth with Ergo Depth Gauge (321-19-09) or the new GPS 3.2mm Drill Guide when navigating the screw placement.

Note: The surgeon should drill in reverse upon removal of the drill bit from the bone.

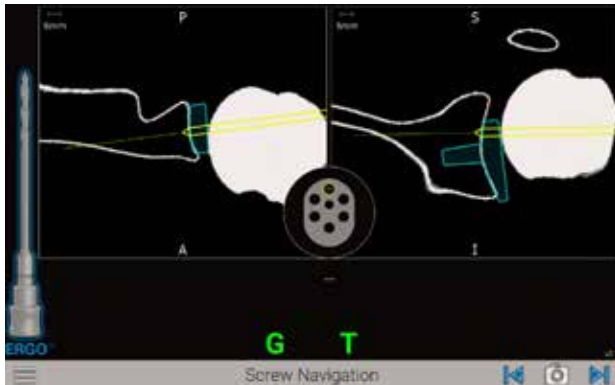

Figure 71a

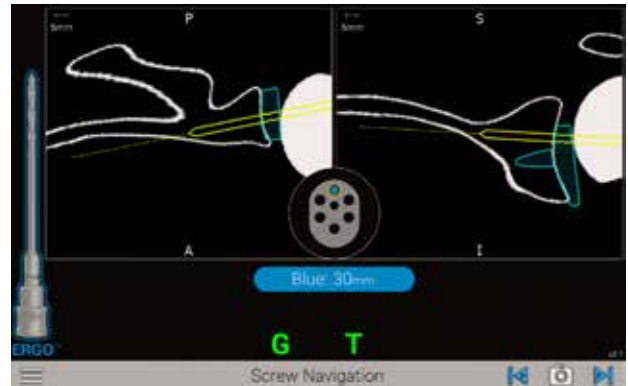

Figure 71b



Figure 72

Note: The baseplate holes and guide tip should be cleared of debris before screwing holes, as this can affect the depth indication (on the screen and on the drills).

Place the **GPS 3.2mm Drill Guide** tip into the preferred hole of the Glenoid Baseplate and prepare to drill the **3.2mm Drill** hole (Figure 72).

The screen will display the trajectory of the Drill to allow for aiming for bicortical fixation, for example (Figures 71a and 71b). If the implant placement has successfully digitized, information related to the screw length will appear on the screen, along with active screw hole location.

If not successfully digitized, information about screw length will NOT appear on the screen. Use the Ergo 3.2mm drill

guide sleeve or a depth gauge to measure the screw length and location.

Drill the **Ergo GPS 3.2mm Drill** through the **3.2mm Guide** and Baseplate hole. Once finished drilling the holes, be sure to disconnect the 3.2mm Drill from the Driver and remove it from the Drill Guide.

Note: Ensure the drill depth indicator reaches the base of the numeric engraving for the respective screw length.

Once the GPS technique is complete, remove the G Tracker and Coracoid Block before Glenosphere insertion.

Complete remaining surgical steps per Equinox surgical technique 718-01-30.

INSTRUMENT LISTING

CATALOG NUMBER	PART DESCRIPTION
----------------	------------------

KIT-501, KIT501C or KIT-501+		GPS Station
------------------------------	--	-------------

KIT-501, KIT501C or KIT-501+	GPS Station
100025	Main GPS Unit
100021	Power Supply
J00010	Lower Mounting Arm
J00012 or J00020	Upper Mounting Arm
J00011	Upper Mounting Arm
100022	Upper Mounting Arm



KIT-501T		GPS Trackers
----------	--	--------------

A10003	GPS Probe
--------	-----------



A10005	GPS T-Tracker
--------	---------------



A10006	GPS G-Tracker
--------	---------------



Note: F Tracker currently used for knee cases only

KIT-531ERGO		GPS Shoulder Mechanical Instruments
-------------	--	-------------------------------------

531-07-05	Impactor Handle
-----------	-----------------



531-01-03	Coracoid Block Left
531-01-04	Coracoid Block Right



531-55-00	Ergo GPS Pilot-tip Driver
-----------	---------------------------



531-55-09	Ergo GPS 3.2mm Drill Guide
-----------	----------------------------



CATALOG NUMBER

PART DESCRIPTION

531-55-62: Short (silver)
 531-55-64: STD (gold)
 531-55-66: EXT (rose gold)

Ergo GPS Pilot-tip Center Drill Bits



521-78-11

Pin Driver, Short Low Profile



KIT-531A

GPS Shoulder Anatomic Instruments

531-27-04

Peripheral Peg Drill Guide, Left



531-27-05

Peripheral Peg Drill Guide, Right



531-27-14

8 Degree Posterior Augment Peripheral Peg Drill Guide, Left



531-27-15

8 Degree Posterior Augment Peripheral Peg Drill Guide, Right



531-29-14

16 Degree Posterior Augment Peripheral Peg Drill Guide, Left



531-29-15

16 Degree Posterior Augment Peripheral Peg Drill Guide, Right



531-07-50

Shoulder GPS Hudson Adapter



GPS Shoulder Disposables

531-78-20

Disposable Hex Pins Kit



531-55-88

Ergo GPS Disposable Reverse Drill Kit



A10012

GPS Disposable Kit

- Includes sterile drape, batteries and cleaning wipe



SOFTWARE REQUIREMENTS

THE EQUINOXE® PLANNING APP IS AVAILABLE FOR MAC AND PC.

Planning software minimum requirements:

- Equinoxe Planning App is qualified for Windows 10 environment as well as Mac OS 11 (BigSur) and Mac OS 12 (Monterey).
- It is recommended to have 8GB or more of RAM, and a screen resolution of a least 1280x800 pixels.
- It is recommended to have at least 10Gb free space on disk.
- It is mandatory to have Administrator rights during software installation.
- If network security measures are implemented (Web filtering, firewall, proxy) it may be necessary to ask the IT department to ensure communication (https, port 443) is possible.
- Graphical hardware must support at least OpenGL v3.3. Graphics cards and chipsets made after 2010, with up-to-date drivers, should satisfy this condition.

GPS® is manufactured by Blue Ortho and distributed by Exactech, Inc.

Exactech, Inc. is proud to have offices and distributors around the globe. For more information about Exactech products available in your country, please visit www.exac.com.

For additional device information, refer to the Exactech Shoulder System—Instructions for Use for information including, but not limited to, a device description, indications, contraindications, precautions and warnings. For further product information, please contact Customer Service, Exactech, Inc., 2320 NW 66th Court, Gainesville, Florida 32653-1630, USA. (352) 377-1140, (800) 392-2832 or FAX (352) 378-2617.

Exactech, as the manufacturer of this device, does not practice medicine, and is not responsible for recommending the appropriate surgical technique for use on a particular patient. Because this information does not purport to constitute any diagnostic or therapeutic statement with regard to any individual medical case, each patient must be examined and advised individually, and this document does not replace the need for such examination and/or advice in whole or in part. These guidelines are intended to be solely informational and each surgeon must evaluate the appropriateness of these guidelines based on his or her personal medical training and experience. Prior to use of this system, the surgeon should refer to the product package insert for information including, but not limited to, comprehensive warnings, precautions, indications for use, contraindications and adverse effects.

The products discussed herein may be available under different trademarks in different countries. All copyrights, and pending and registered trademarks, are property of Exactech, Inc. **This material is intended for the sole use and benefit of the Exactech sales force and physicians; it is not intended for laypersons.** It should not be redistributed, duplicated or disclosed without the express written consent of Exactech, Inc. ©2024 Exactech, Inc. OPTECH-000020/C 0624



EXACTECH, INC.
2320 NW 66TH COURT
GAINESVILLE, FL 32653 USA

+1 352.377.1140
+1 800.EXACTECH
+1 352.378.2617 (FAX)
www.exac.com